



XNANO

INSTRUCTIONS FOR USE

FR Guide de l'utilisateur - EN User's guide - DE Bedienungsanleitung - NL Gebruiksaanwijzing - ES Guía del usuario - PT Guia de utilização - IT Manuale d'uso - TR Kullanım kılavuzu - CS Návod k použití - SK Používateľská príručka - HU Használati útmutató - PL Instrukcja obsługi - ET Kasutusjuhend - LT Naudo-totoj vadovas - LV Lietošanas pamācība - BG Ръководство на потребител - RO Ghidul utilizatorului - SL Navodila za uporabnika - HR Upute za uporabu - BS Upute za upotrebu - SR Uputstvo za upotrebu - RU Руководство пользователя - EL Οδηγός χρήσης - UK Посібник користувача - CN 用户指南 - HK 用戶指南 - KO 사용자 가이드 - AR دليل الاستعمال - FA راهنمای کاربر - FI Kayttoopas NO Brukermanual - DA Bruger manual - MY Panduan pengguna



15 YEARS REPARABILITY



FR Réparable au juste prix 15 ans
DE Reparierbarkeit zum fairen Preis
15 Jahre
IT Riparabile al giusto prezzo 15 anni
ES Reparable a un precio justo 15 años
RU Возможность ремонта по честной цене 15 лет
PL Naprawialny za rozsądną cenę 15 lat
NL Reparatie voor een redelijke prijs 15 jaar
PT Reparável a um preço justo 15 anos
FI Korjattavissa kohtuulliseen hintaan 15 vuotta
NO Kan repareres til rimelig pris 15 år
DA Kan repareres til rimelige priser 15 års

SU Reparationsbar till rimligt pris 15 år
MY R boleh dipasang pada harga wajar 15 tahun
TR Uygun fiyata tamir edilebilir 15 yıl
CS Opravitelné za přijatelnou cenu 15 let
SK Opravitelné za prijateľnú cenu 15 rokov
HU Gazdaságosan javítható 15 év
ET Õiglase hinnaga parandatav 15 aastat
LV Galima taisyti už sąžiningą kainą 15 metų
LT Remontėjams par godią cenu 15 gadi
BG Сервизна поддръжка на разумна цена 15 години
RO Reparabil la un preț accesibil 15 ani

SL Popravljivo za sprejemljivo ceno 15 LET
HR Pristupačna cijena popravka 15 godina
BS Popravljiv po poštenoj cijeni 15 godina
SR Popravka po pristupačnoj ceni 15 godina
UK Можливість ремонту за справедливою ціною 15 років
HK 合理的維修價格 15年
KR 합리적인 수리비용 15년
AR قابل للإصلاح بسعر عادل 15 سنة

FOR MORE INFORMATION

FR Pour plus d'informations / DE Weitere Informationen / NL Voor meer informatie / ES Para más información / PT Para mais informações / IT Per ulteriori informazioni / EL Για περισσότερες πληροφορίες / TR Daha fazla bilgi için / CS Více informací naleznete zde / SK Pre viac informácií / HU További információk / PL Więcej informacji można znaleźć / ET Lisateave / LT Norėdami daugiau informacijos / LV Vairāk informācijas / BG За повече информация / RO Pentru informații suplimentare / SL Več informacij / HR Za više informacija / BS Za više informacija / SR Za više informacija / RU Для получения дополнительной информации / UK Для отримання докладніших відомостей / CN 获取更多信息 / HK 更多信息 / KO 더 자세한 정보는 아래 웹사이트에서 확인하실 수 있습니다 / AR للمزيد من المعلومات / FA برای کسب اطلاعات بیشتر / FI Lisätietoja / NO For mer informasjon / DA For mere information / SU För mer information / MY Untuk maklumat selanjutnya

www.rowenta.com



www.tefal.com

www.obhnordica.se

2220005127-01 - 45/2021

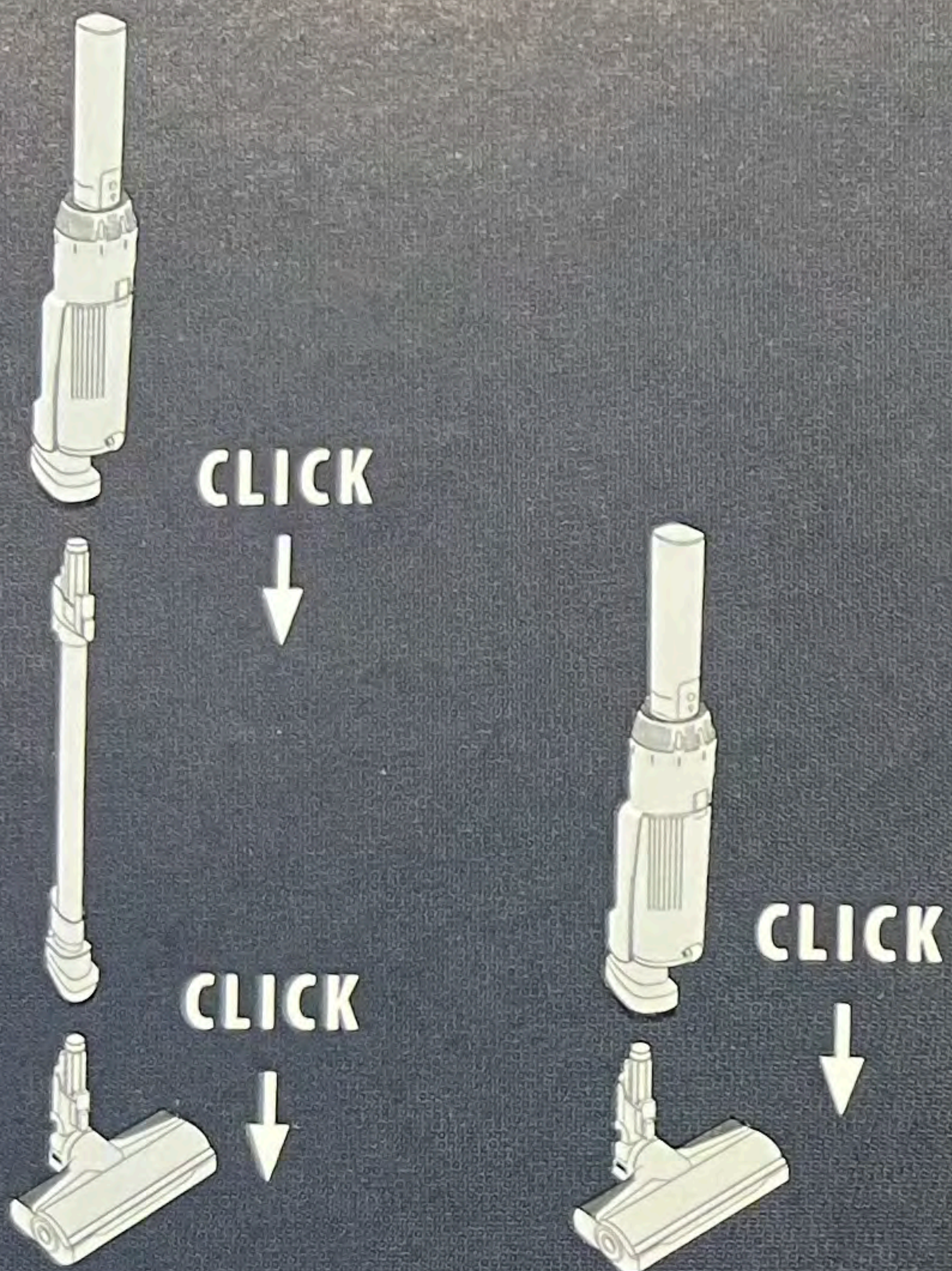
RH11 - TY11 - EO11

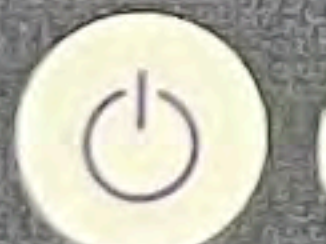

	 ON	BOOST
	UP TO 40 min	UP TO 14 min
	UP TO 25 min	UP TO 13 min

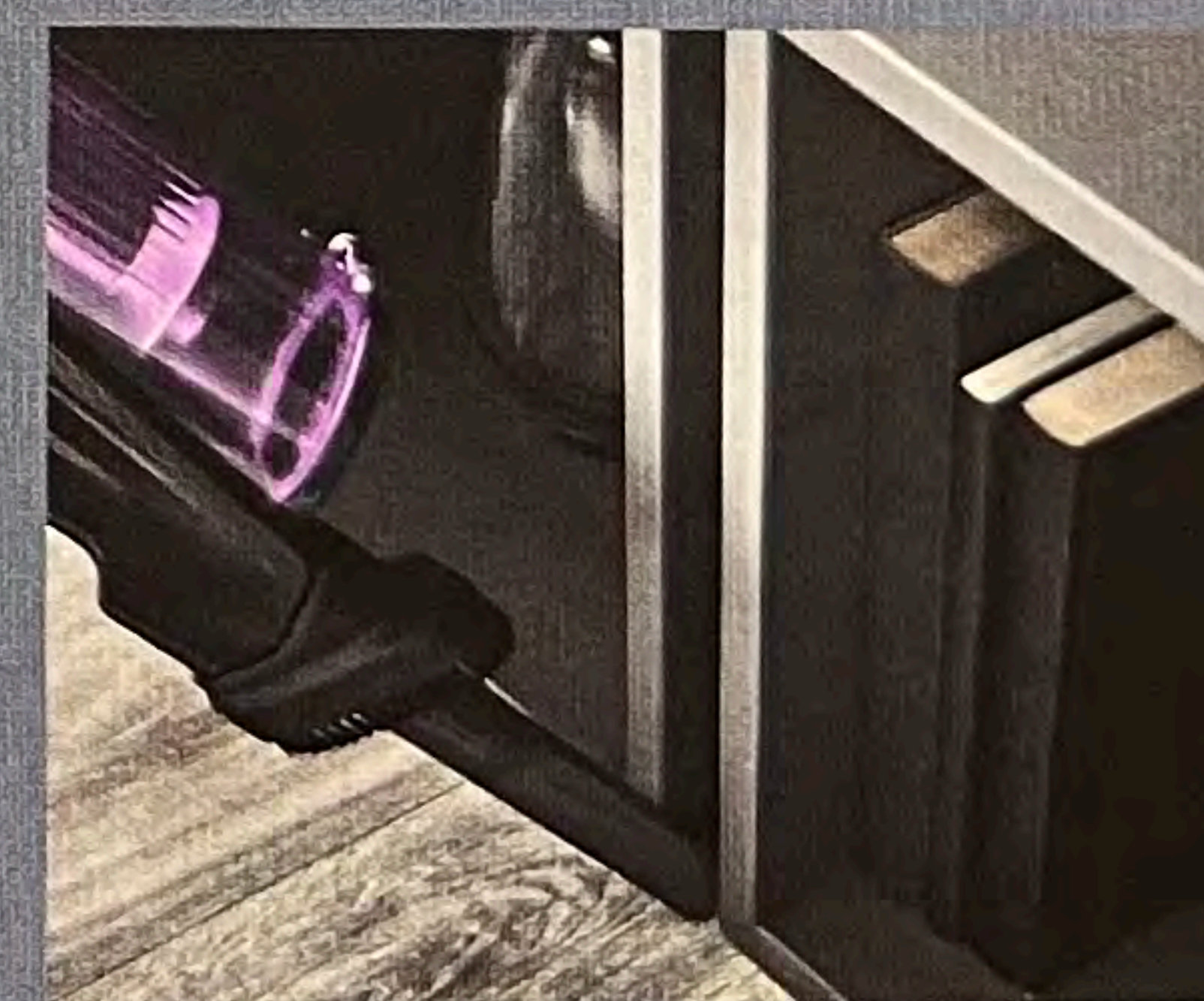

* EN Depending on model / FR Selon modèle / DE Je nach Modell / NL Afhankelijk van het model / ES Según modelo / PT Consoante o modelo / IT Secondo i modelli / EL Ανάλογα με το μοντέλο / TR Modele göre / CS Podle modelu / SK V závislosti od modelu / HU Modelltől függően / PL W zależności od typu / ET Sõltuvalt mudelist / LT Pagal modelį / LV Atbilstoši modelim / BG в зависимост от модела / RO Ovisno o modelu / SL Odvisno od modela / HR Ovisno o modelu

modelu / BS Ovisno o modelu / SR U zavisnosti od modela / RU В зависимости от модели / UK Залежно від моделі / CN 根據不同型號 / HK 根據型號 / KO 모델에 따라 다름 / AR حسب الموديل / FA بسته به مدل / FI Mallista riippuen / NO Avhengig av modell / DA Afhængig af model / SU Beroende på modell / MY Bergantung pada model



YouTube



#A

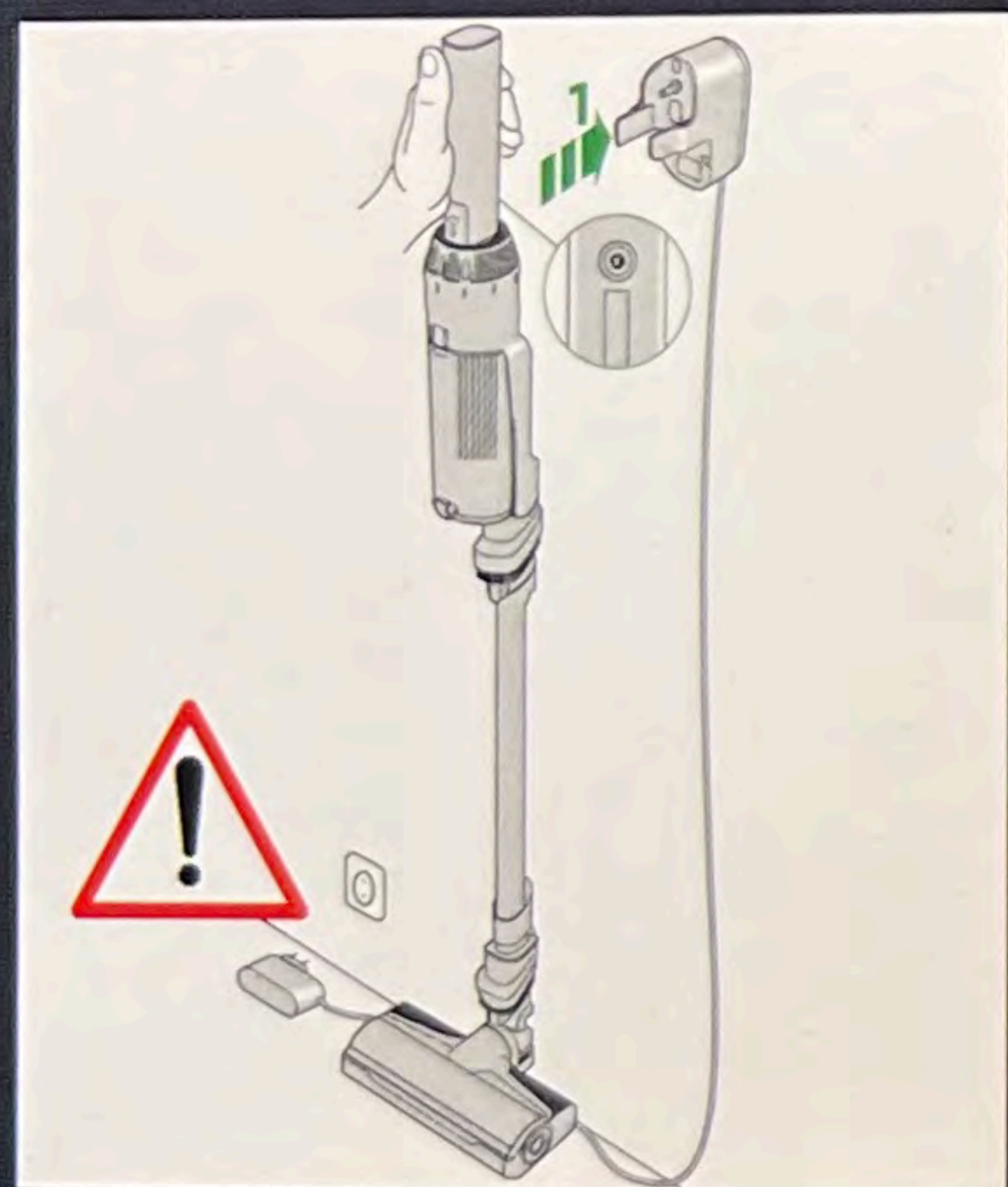
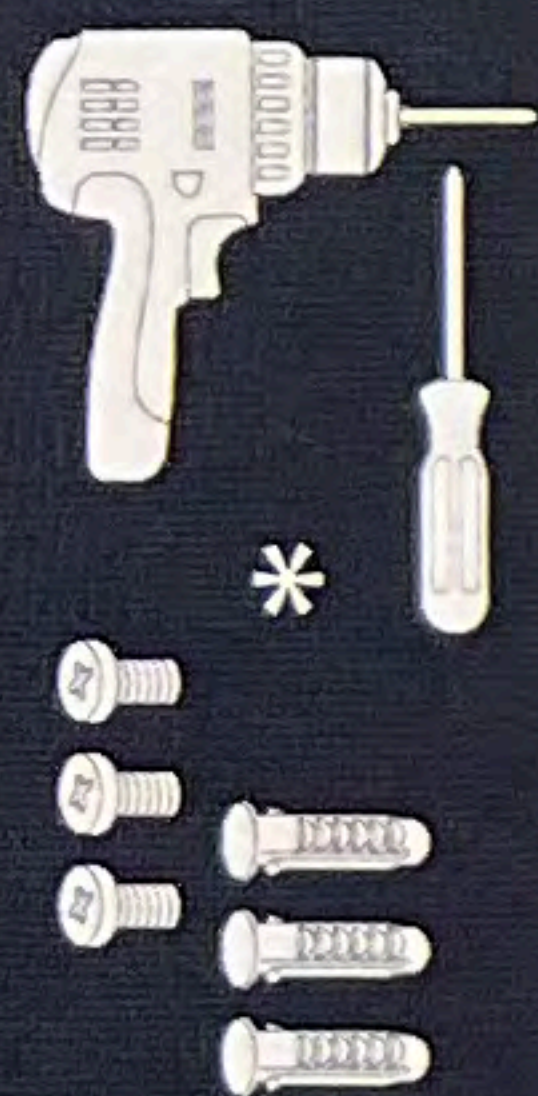

A.1

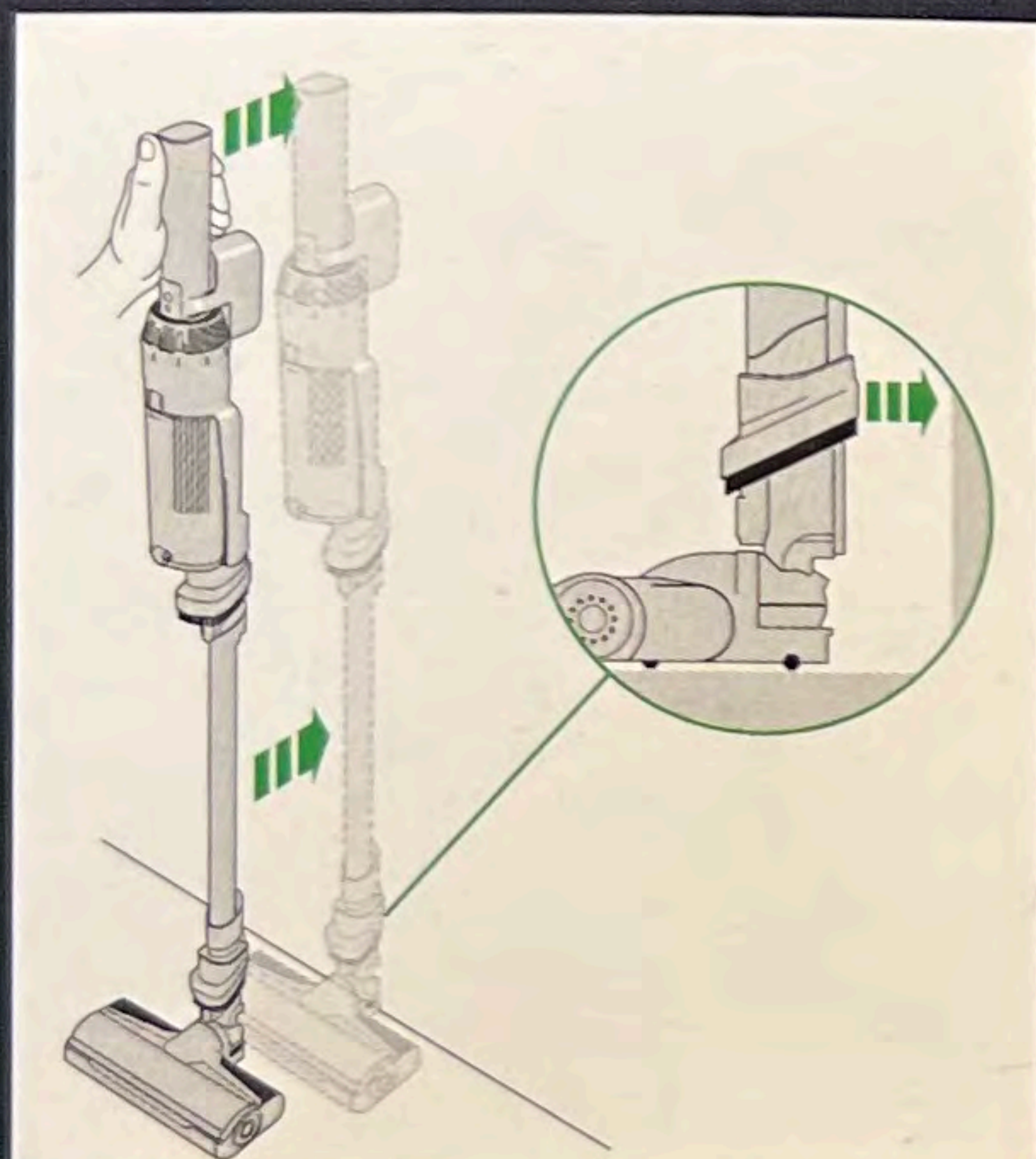

A.2

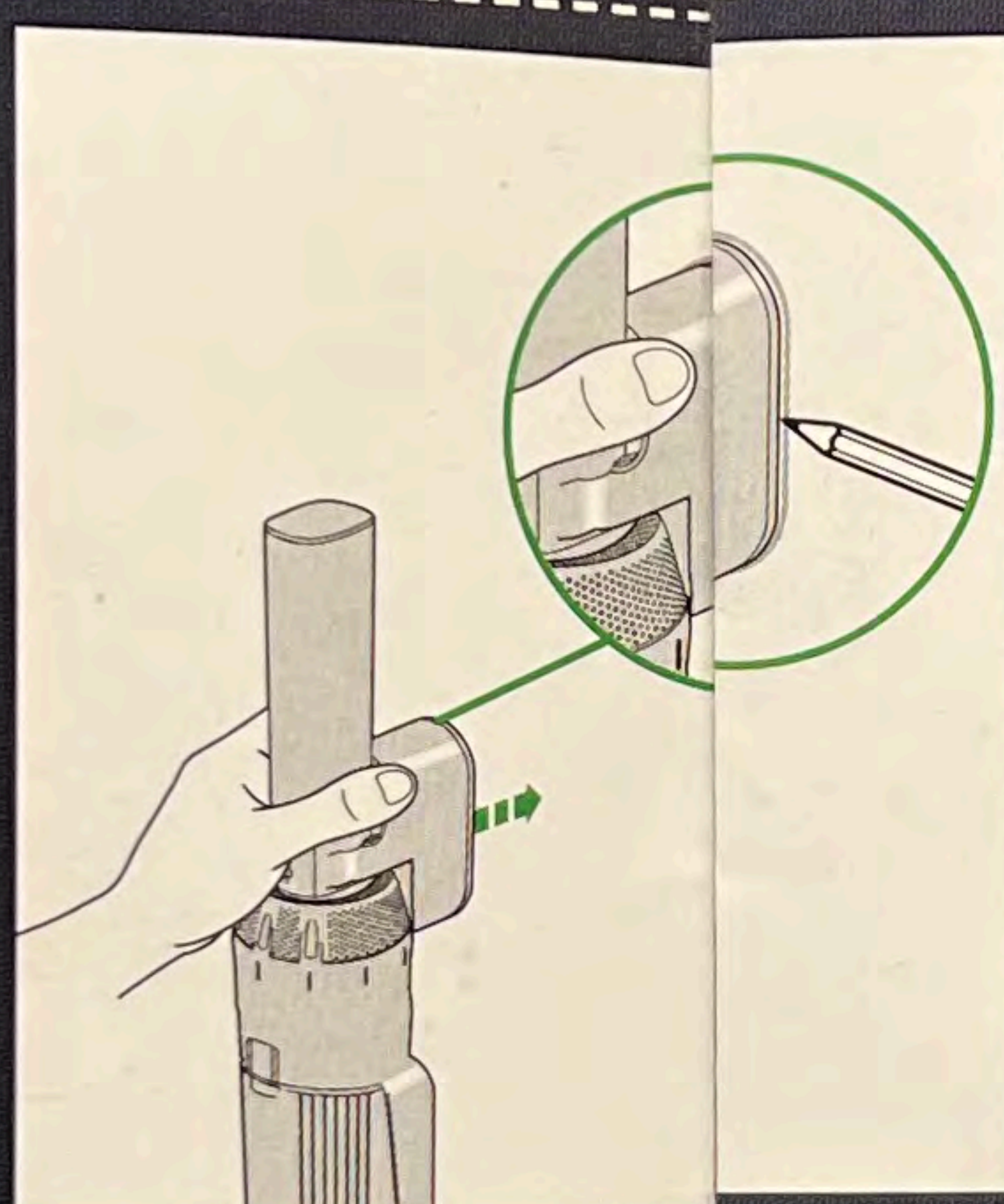

A.3

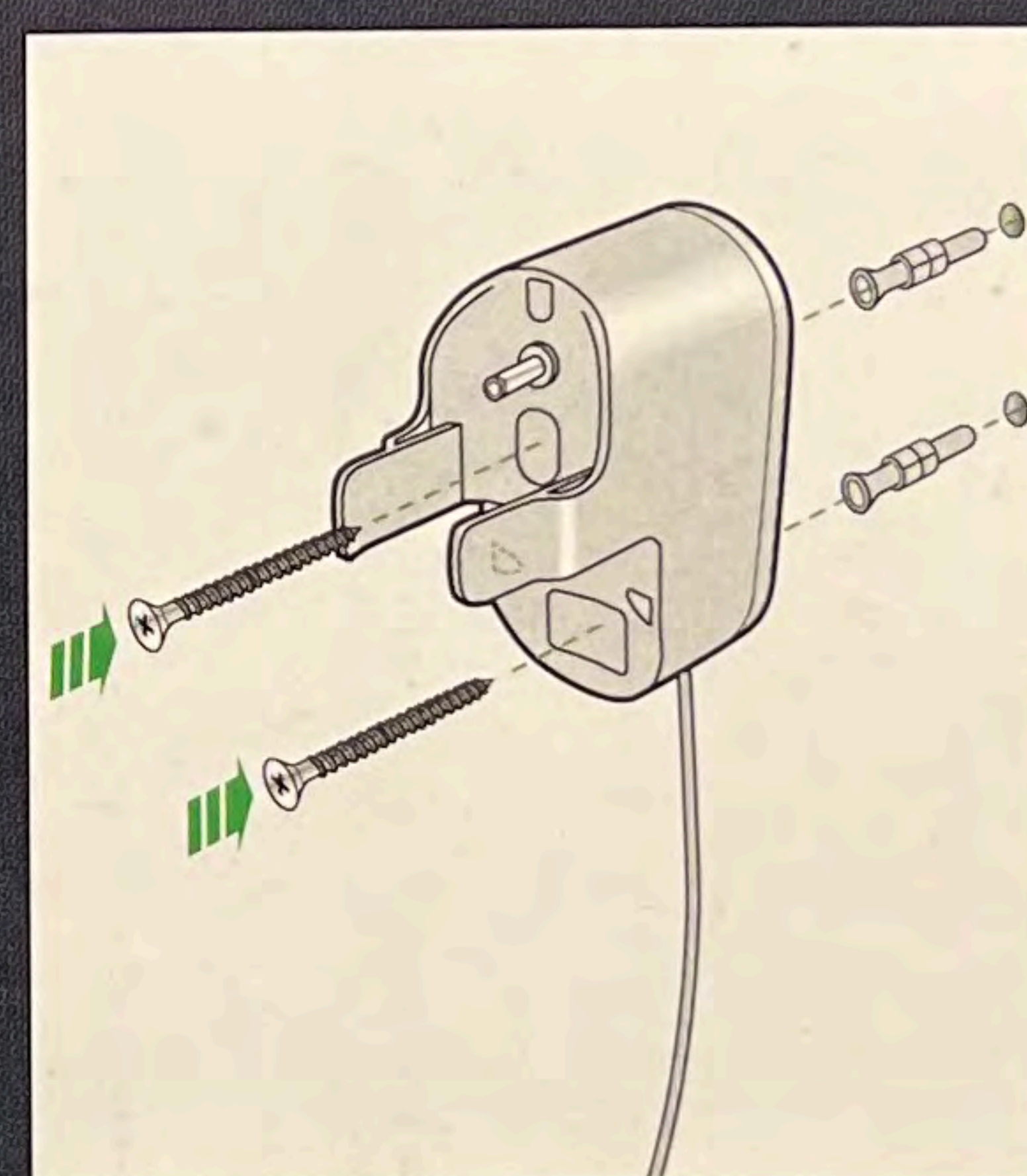

A.4

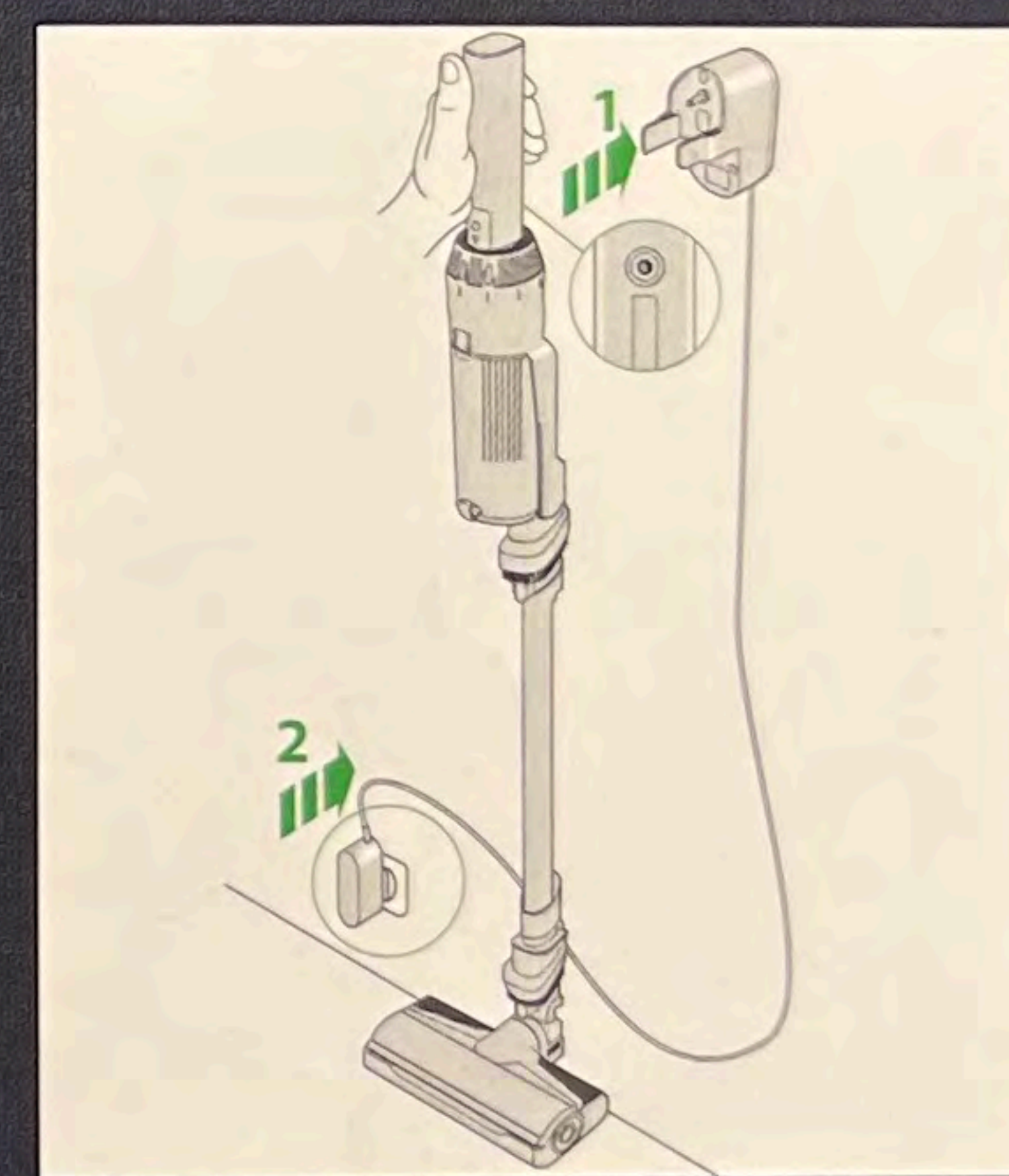

A.5

#B



B.1

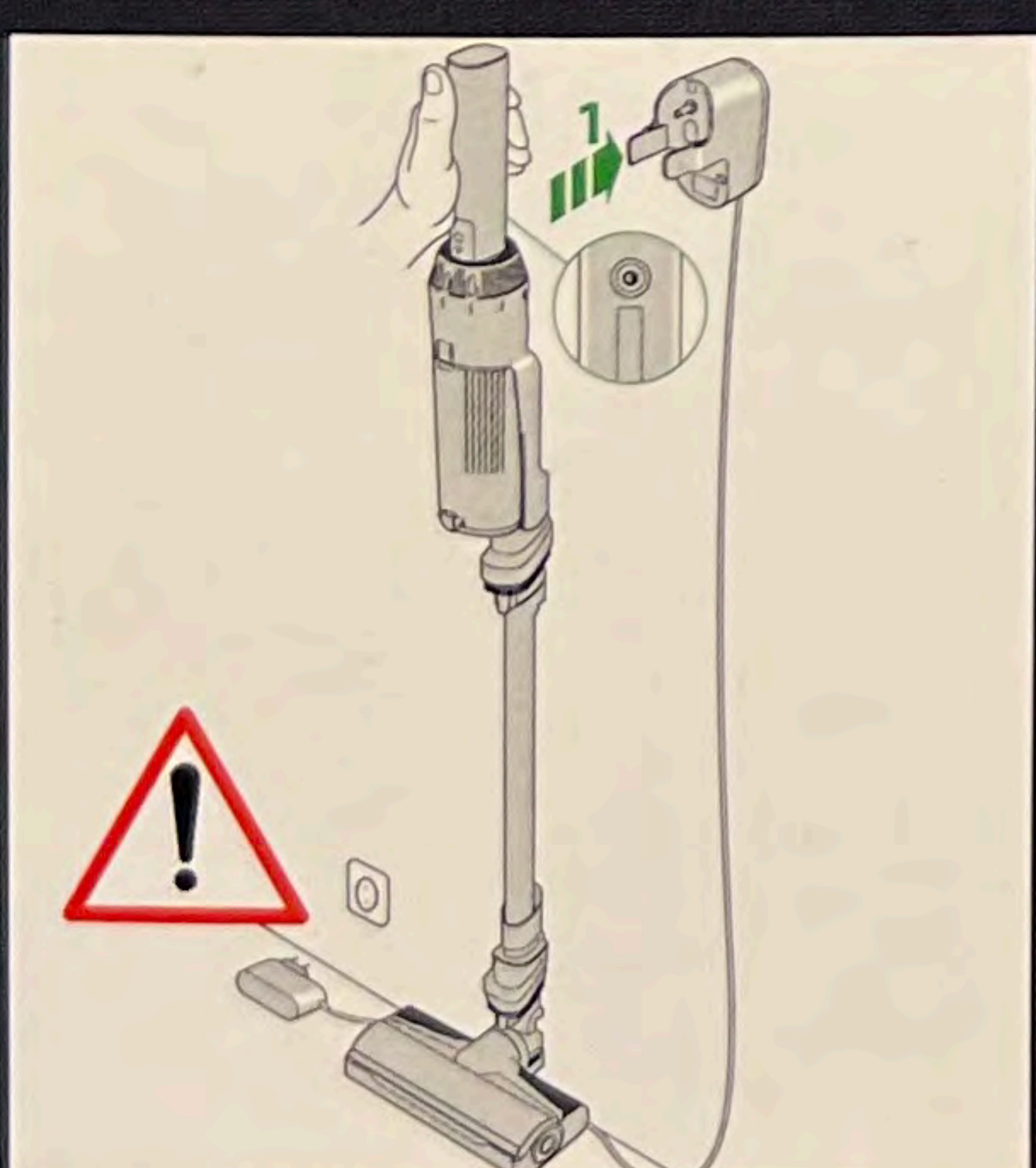

B.2

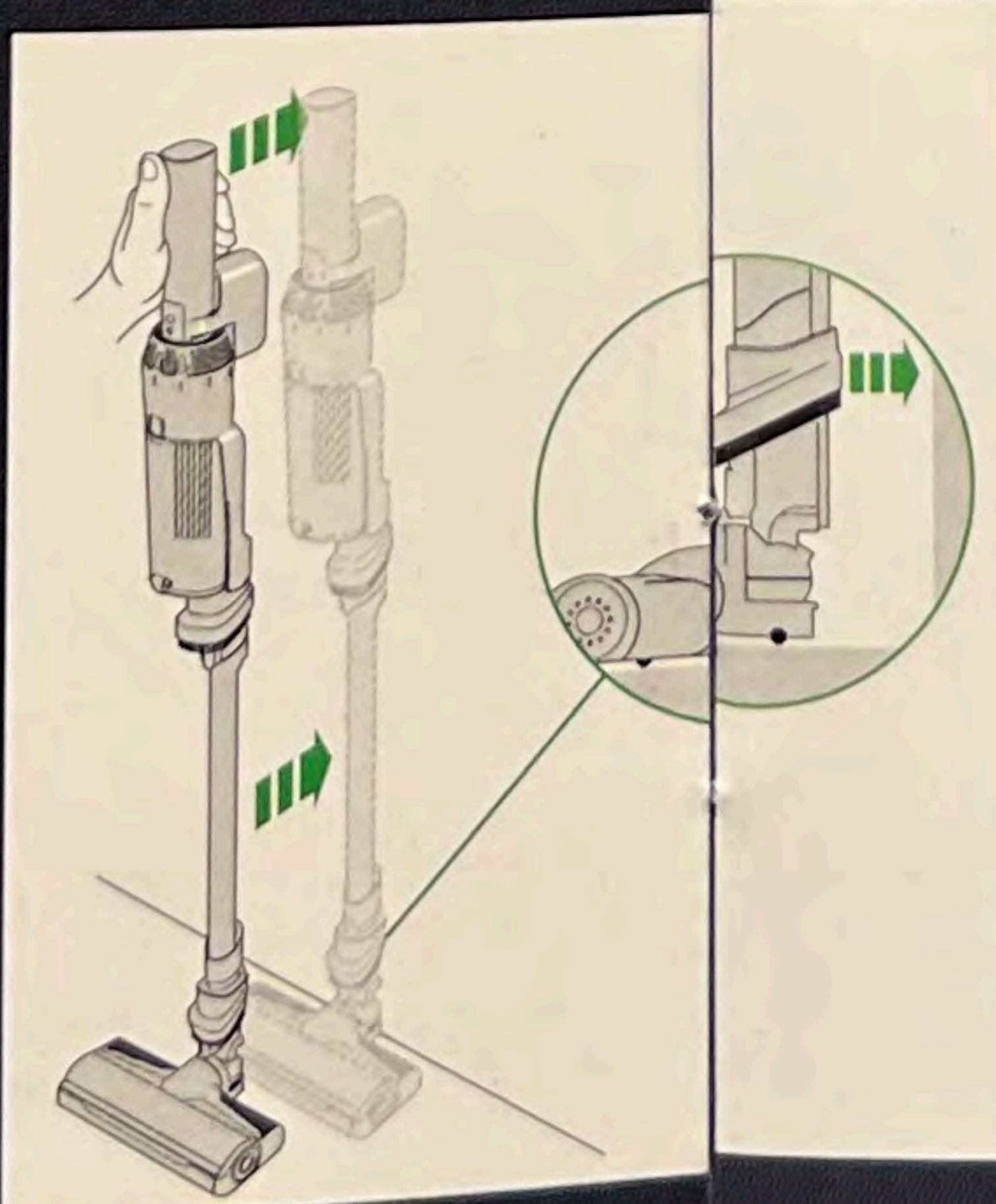

B.3

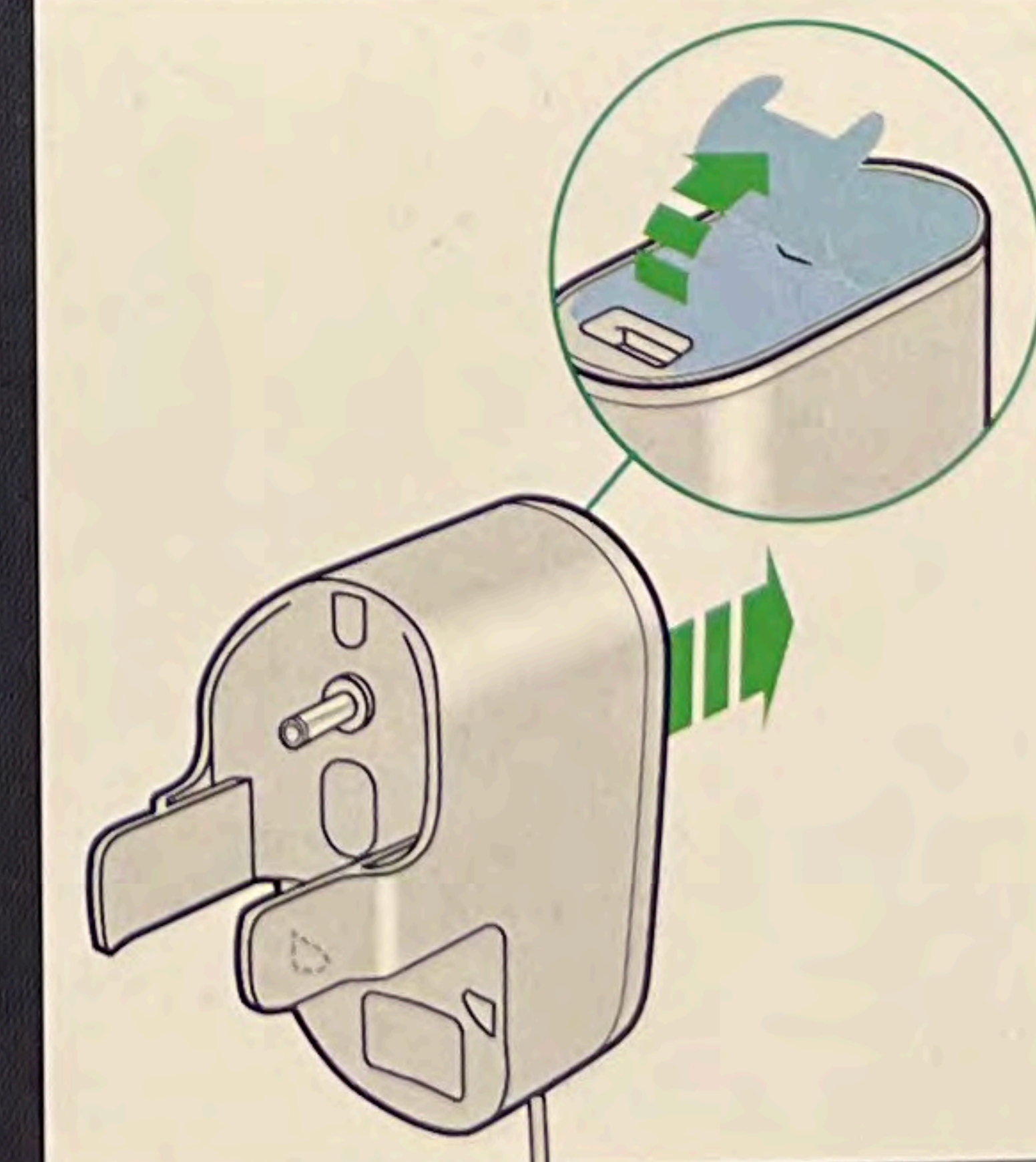

B.4

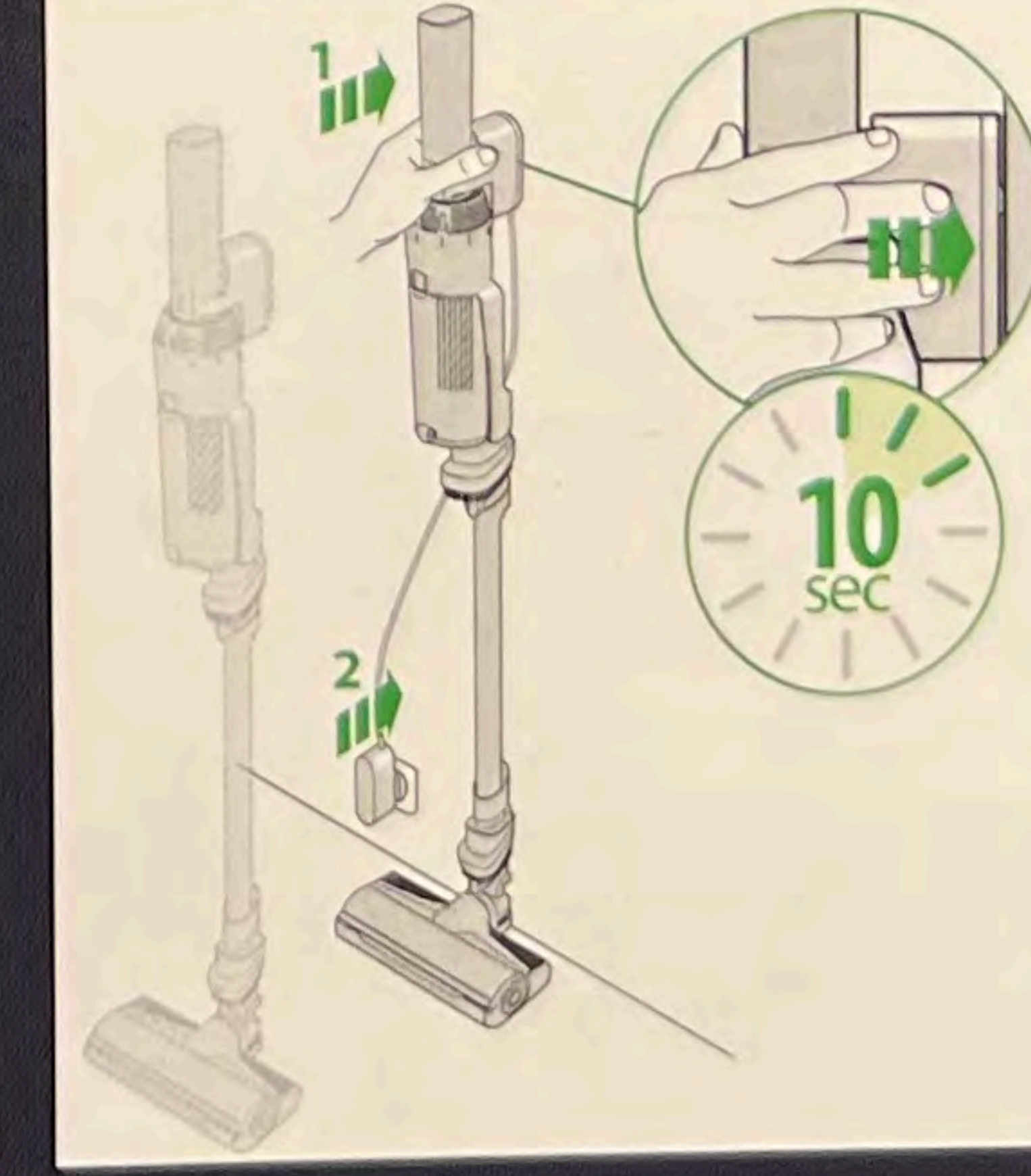

B.5

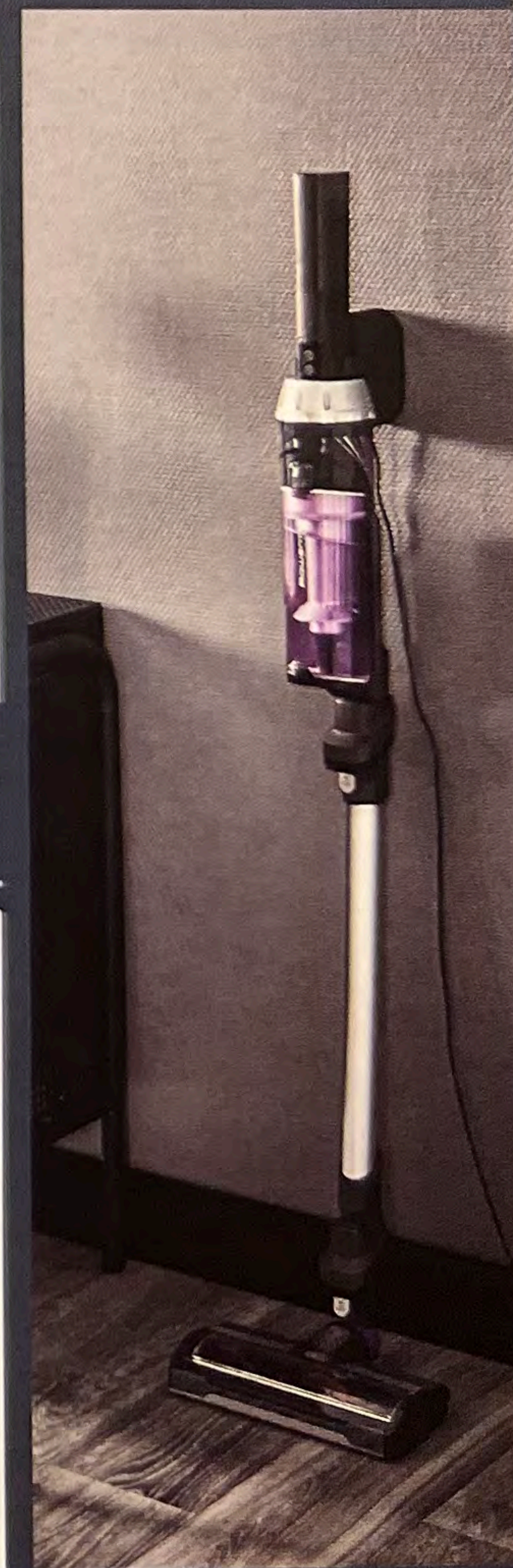

* EN Not included / FR Non inclus / DE Nicht im Lieferumfang enthalten / NL Niet inbegrepen / ES No incluidos / PT Nao incluidos / IT Non incluso / TR Dahil değil / CS Není součástí balení / SK Nezahrnuté / HU Nem tartozék / PL Nie zawiera / ET Valja arvatud / LT Nėra įtraukta / LV Nav ietverts / BG Не са включени / RO Neinclus / SL Ni vključeno / HR Nisu uključeni / BS Nije uključeno / AR غير مرفقة / FA شامل نمی شود / FI Ei sisally / NO ikke inkludert / DA ikke inkluderet / SU ingar ej / MY Tidak termasuk

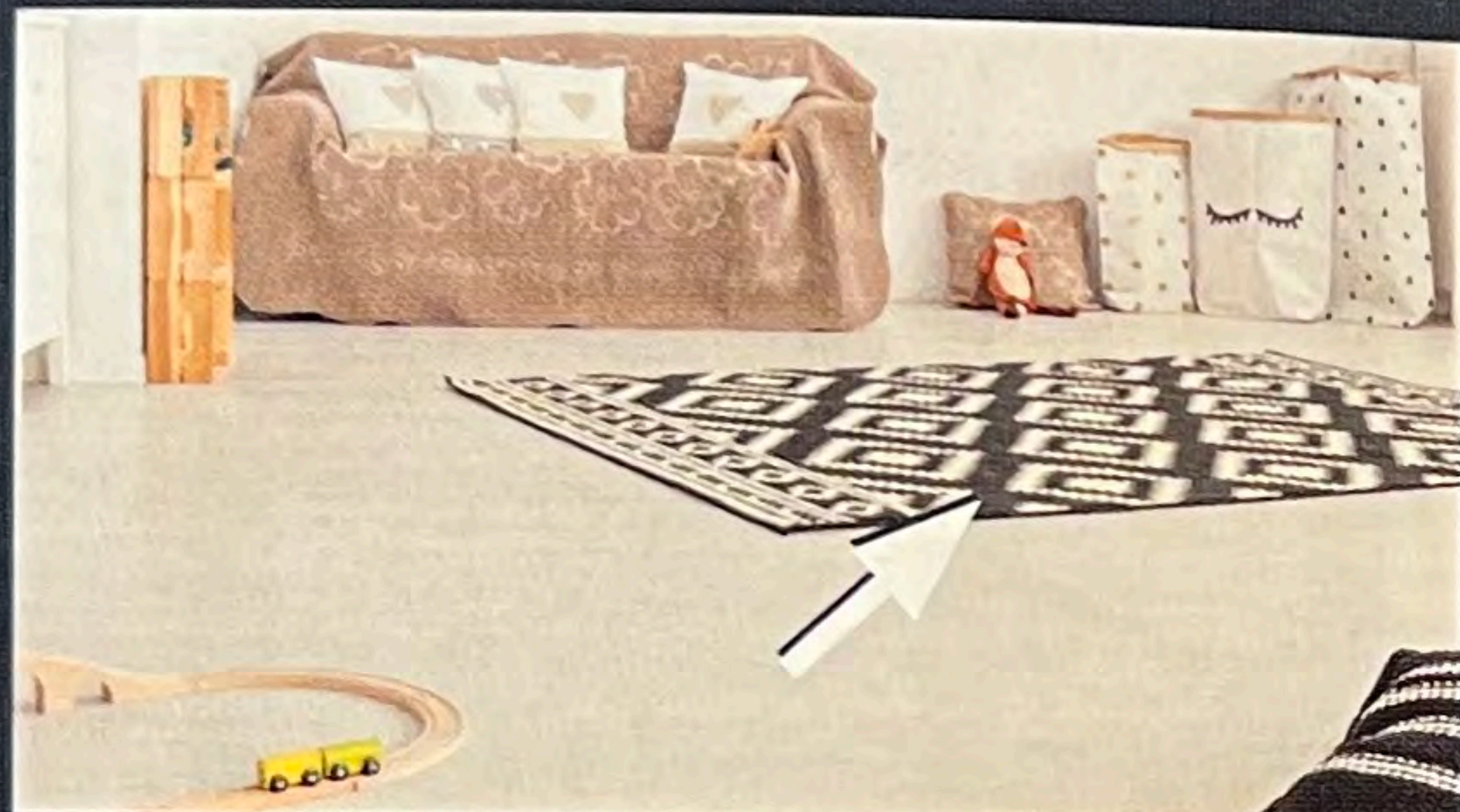
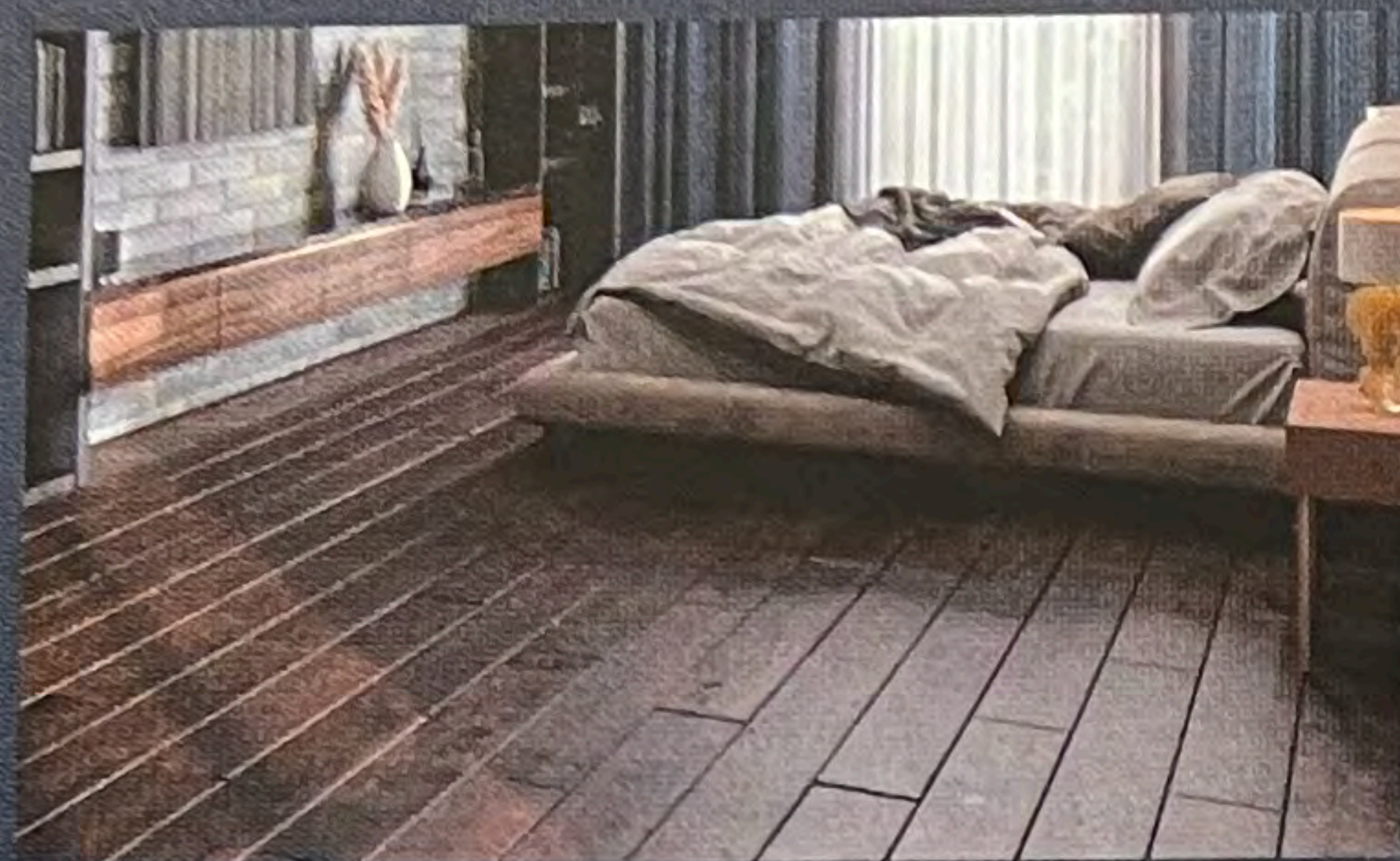

ON / OFF

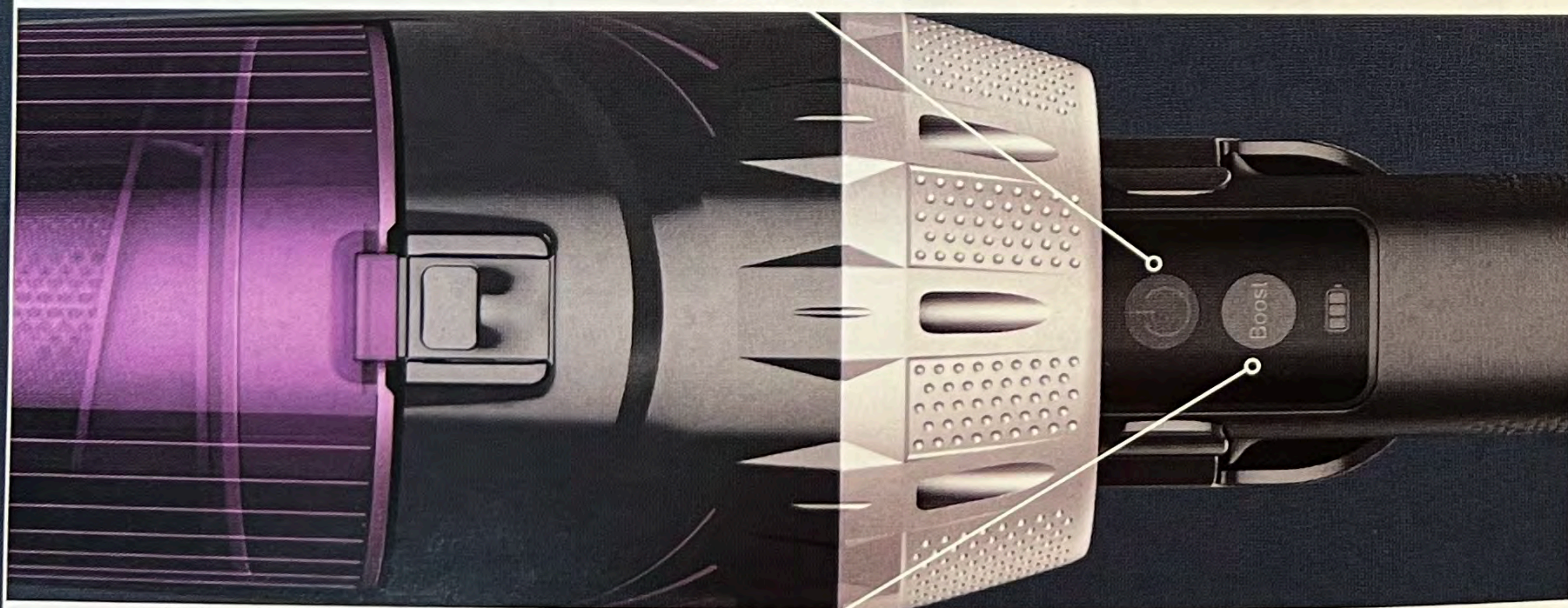

BOOST

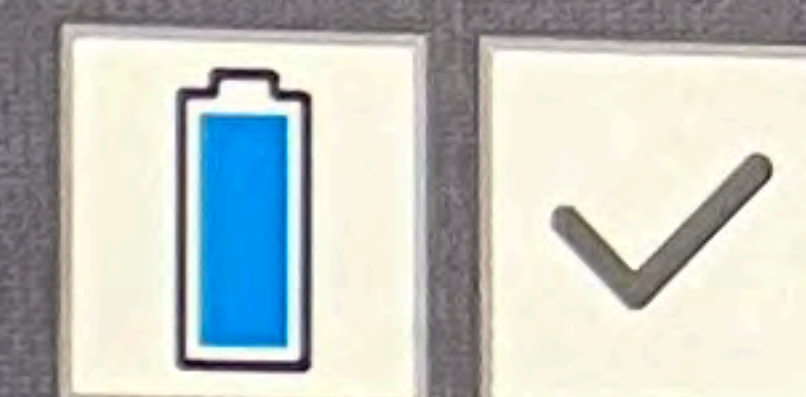
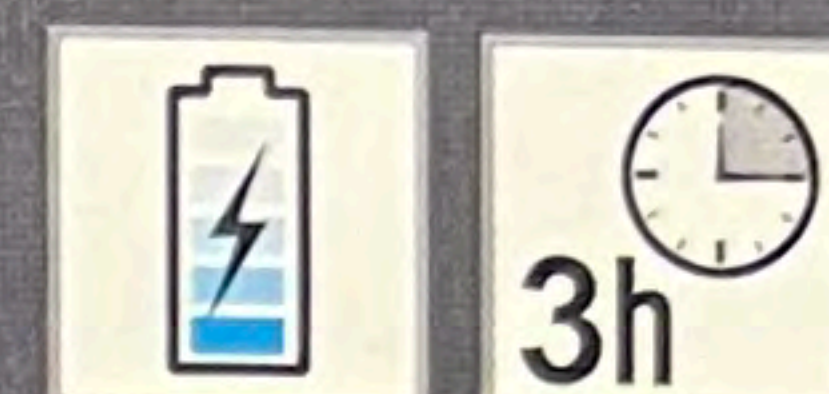
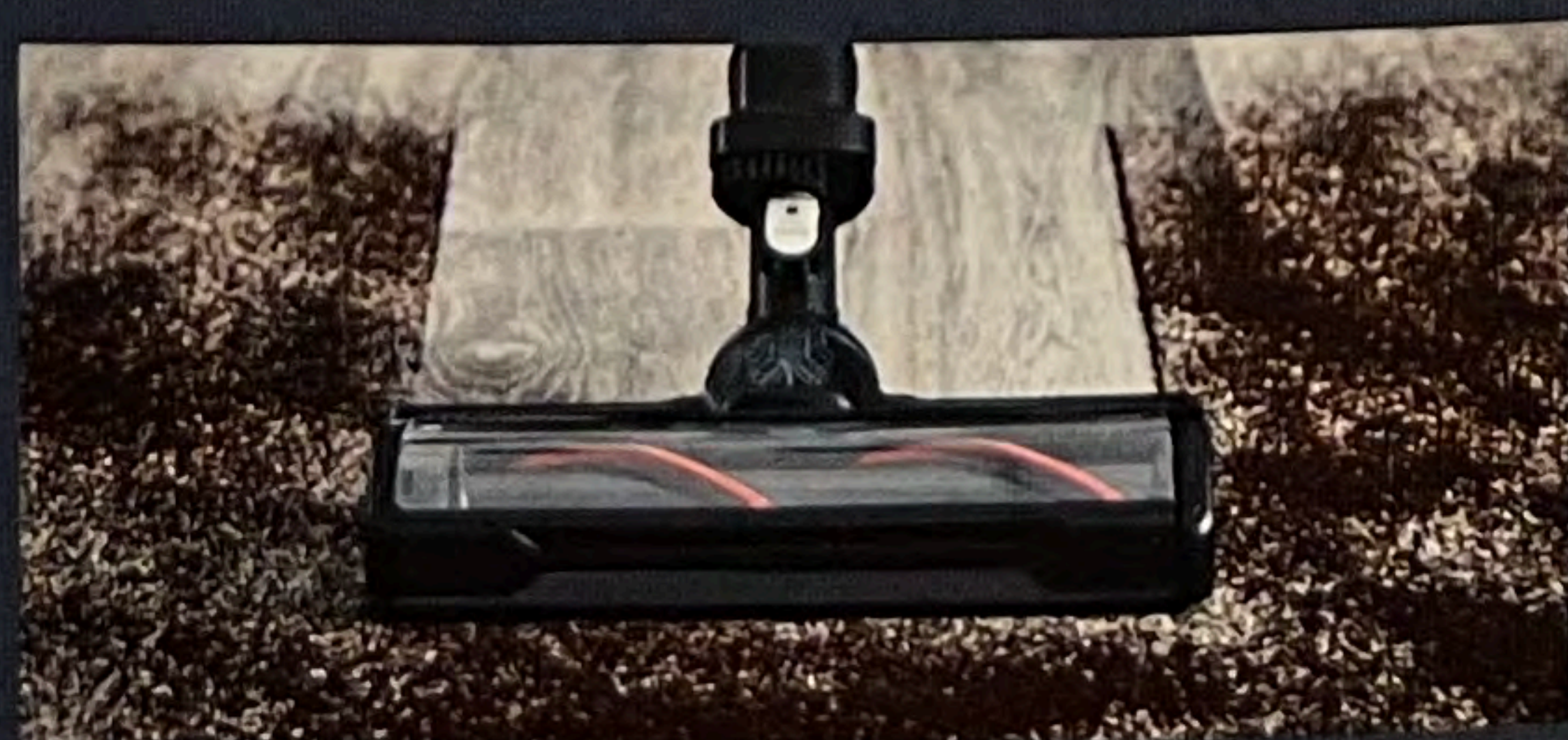

ON

BOOST





☞ 1X / WEEK* - * FR Semaine - DE Woche - IT Settimana - ES Semana - RU Неделя - PL Tydzień - NL Week - PT Semana - EL Εβδομάδα - TR Hafta - CS Týden - SK Týždeň - HU Hét - ET Nädal - SLV Avasitë - LT Nedėļa - BG Седмица - RO Săptămână - SL Teden - HR Tjedan - BS Sedmica - SR Nedelja - UK Тиждень - CN 星期 - HK 星期 - KR 주 - AR أسبوع / FA هفته - FI Viikko - NO Uke - DA Uge - SU Vecka - MY Minggu

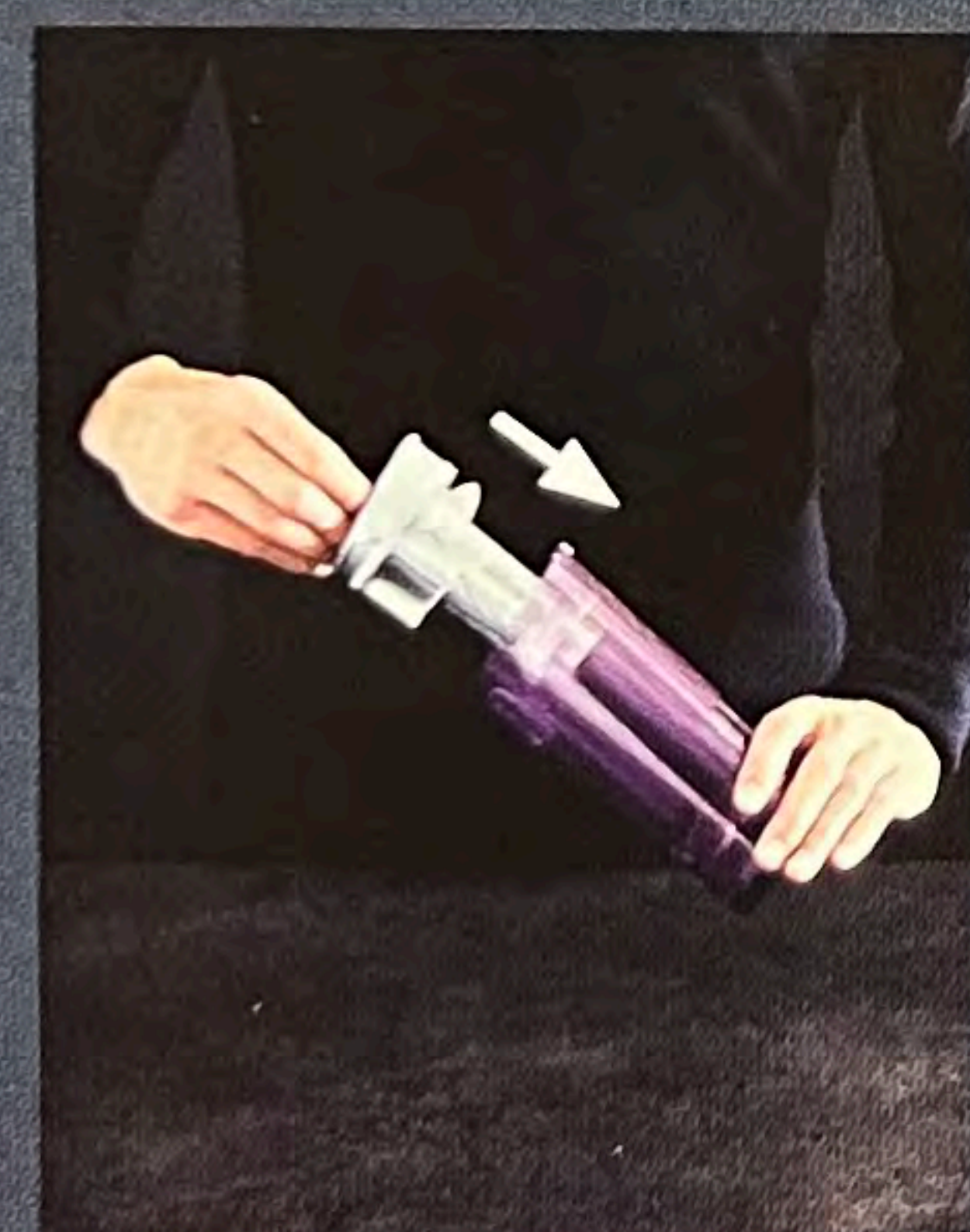
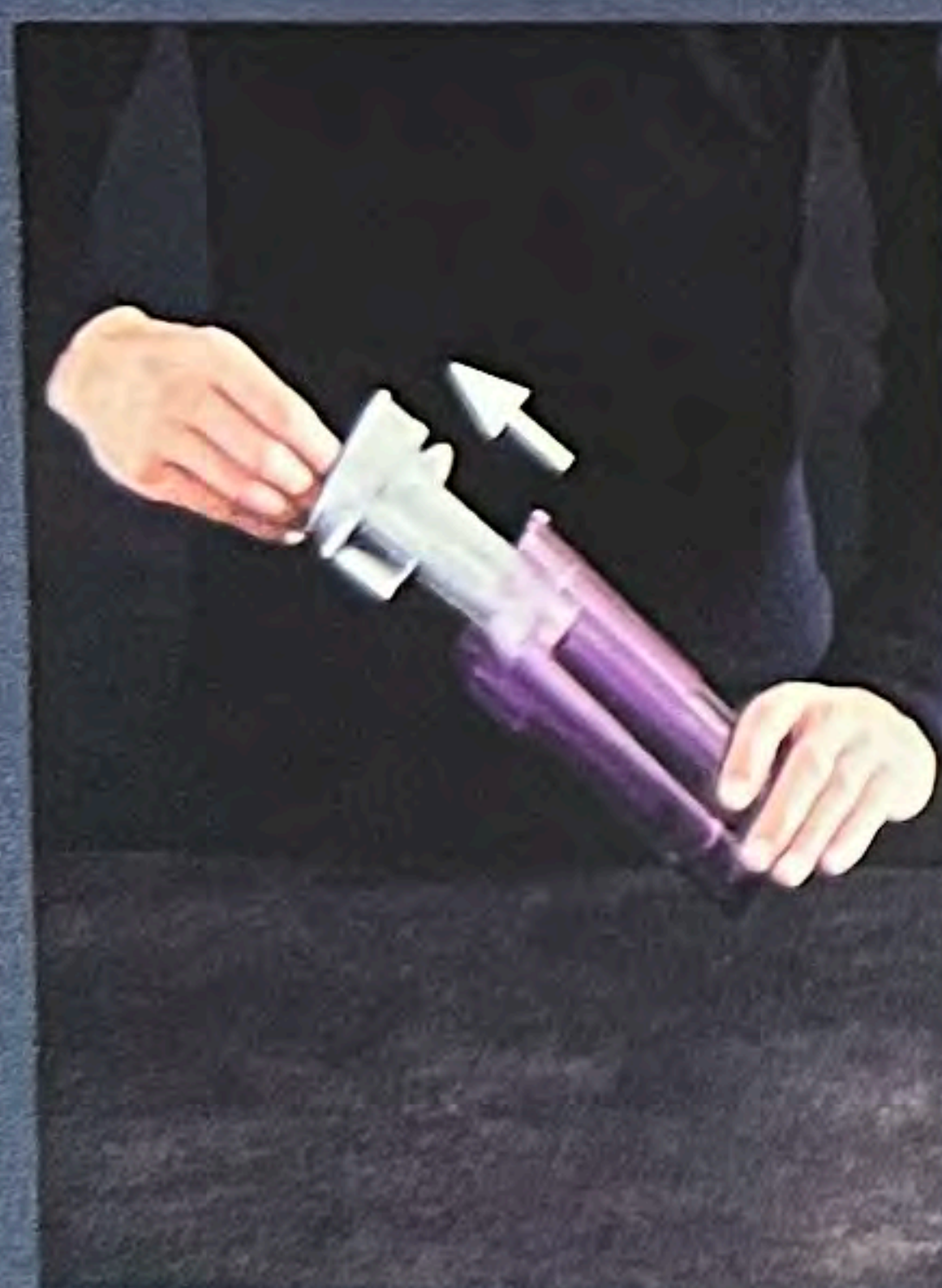
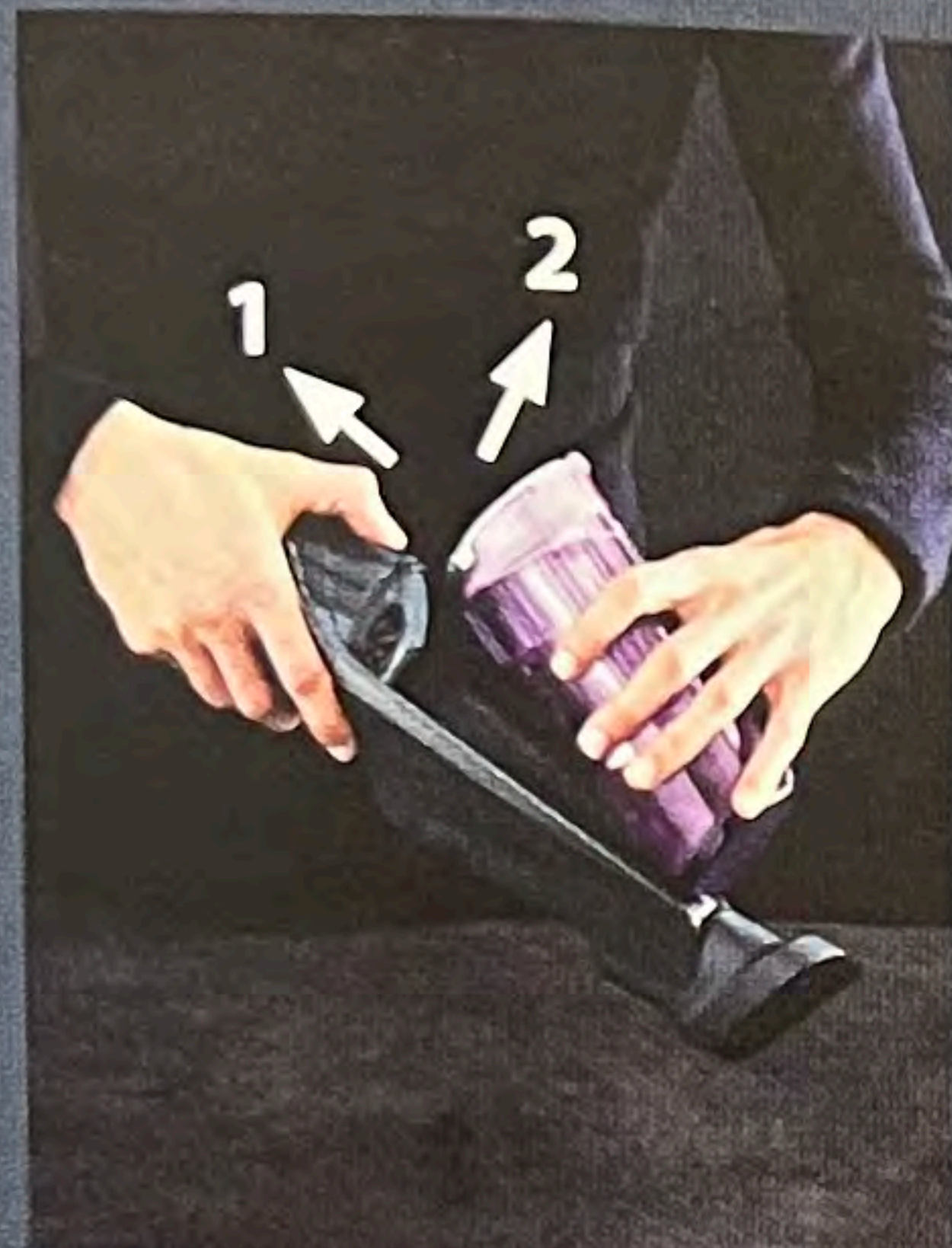
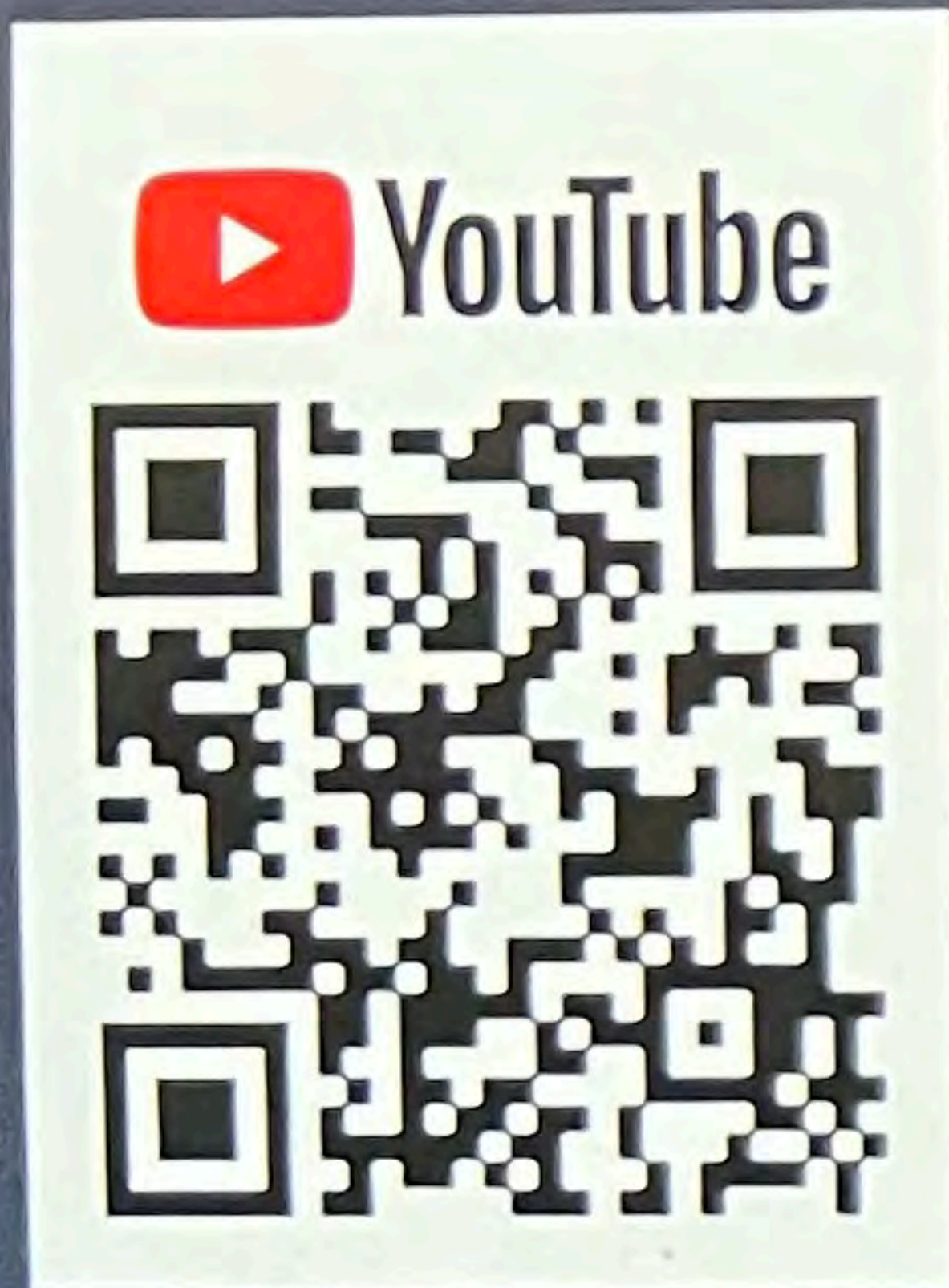

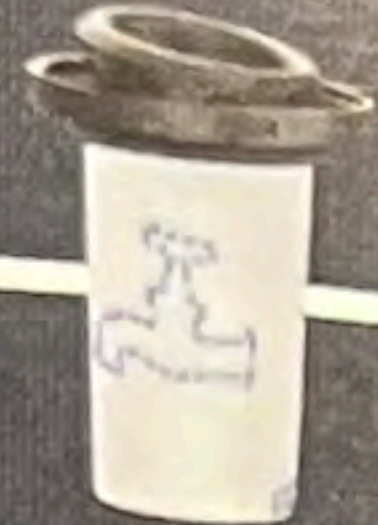

EASY WASH

YouTube

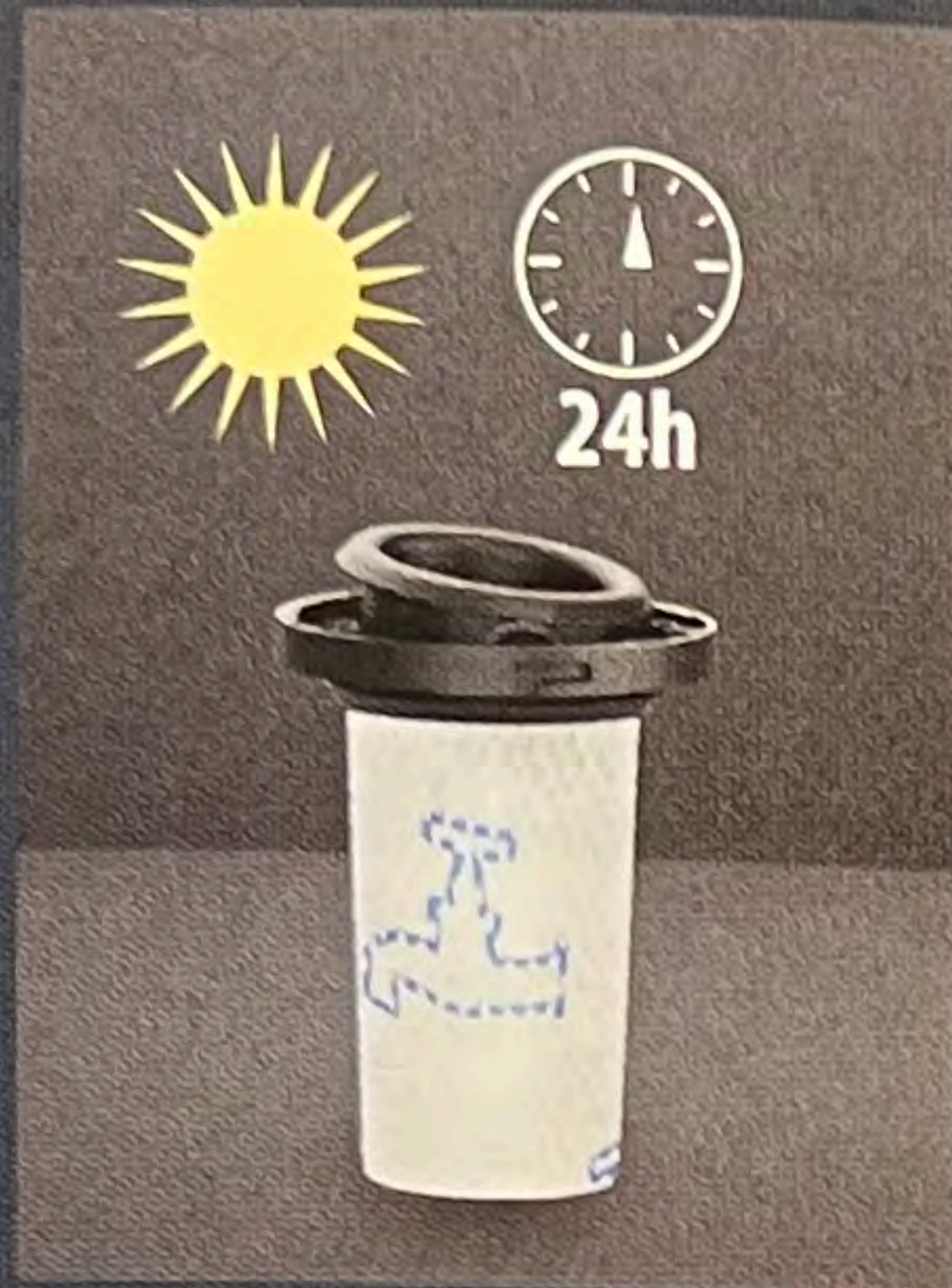

1X / WEEK* - * FR Semaine - DE Woche - IT Settimana - ES Semana - RU Неделя - PL Tydzień - NL Week - PT Semana - EL Εβδομάδα - TR Hafta - CS Týden - SK Týždeň - HU Hét - ET Nädal - SLV Avasitë - LT Nedėļa - BG Седмица - RO Săptămână - SL Teden - HR Tjedan - BS Sedmica - SR Nedelja - UK Тиждень - CN 星期 - HK 星期 - KR 주 - AR أسبوع / FA هفته - FI Viikko - NO Uke - DA Uge - SU Vecka - MY Minggu



2X / YEAR* - * FR an - DE Jahr - IT Anni - ES Año - RU Год - PL Rok - NL Jaar - PT Ano - EL Έτος - TR Yıl - CS Rok - SK Rok - HU Év - ET Év - LT Metai - LV Gads - BG Година - RO An - SL leto - HR Godina - BS Godina - SR Godina - UK Рік - CN 年 - HK 年 - KR 년 - AR سنة / FA سال - FI Vuosi - NO År - DA År - SU År - MY Tahun



1X / WEEK*

* FR Semaine - DE Woche - IT Settimana - ES Semana - RU Неделя - PL Tydzień - NL Week - PT Semana - EL Εβδομάδα - TR Hafta - CS Týden - SK Týždeň - HU Hét - ET Nädal - SLV Avasitë - LT Nedėļa - BG Седмица - RO Săptămână - SL Teden - HR Tjedan - BS Sedmica - SR Nedelja - UK Тиждень - CN 星期 - HK 星期 - KR 주 - AR أسبوع / FA هفته - FI Viikko - NO Uke - DA Uge - SU Vecka - MY Minggu

YouTube

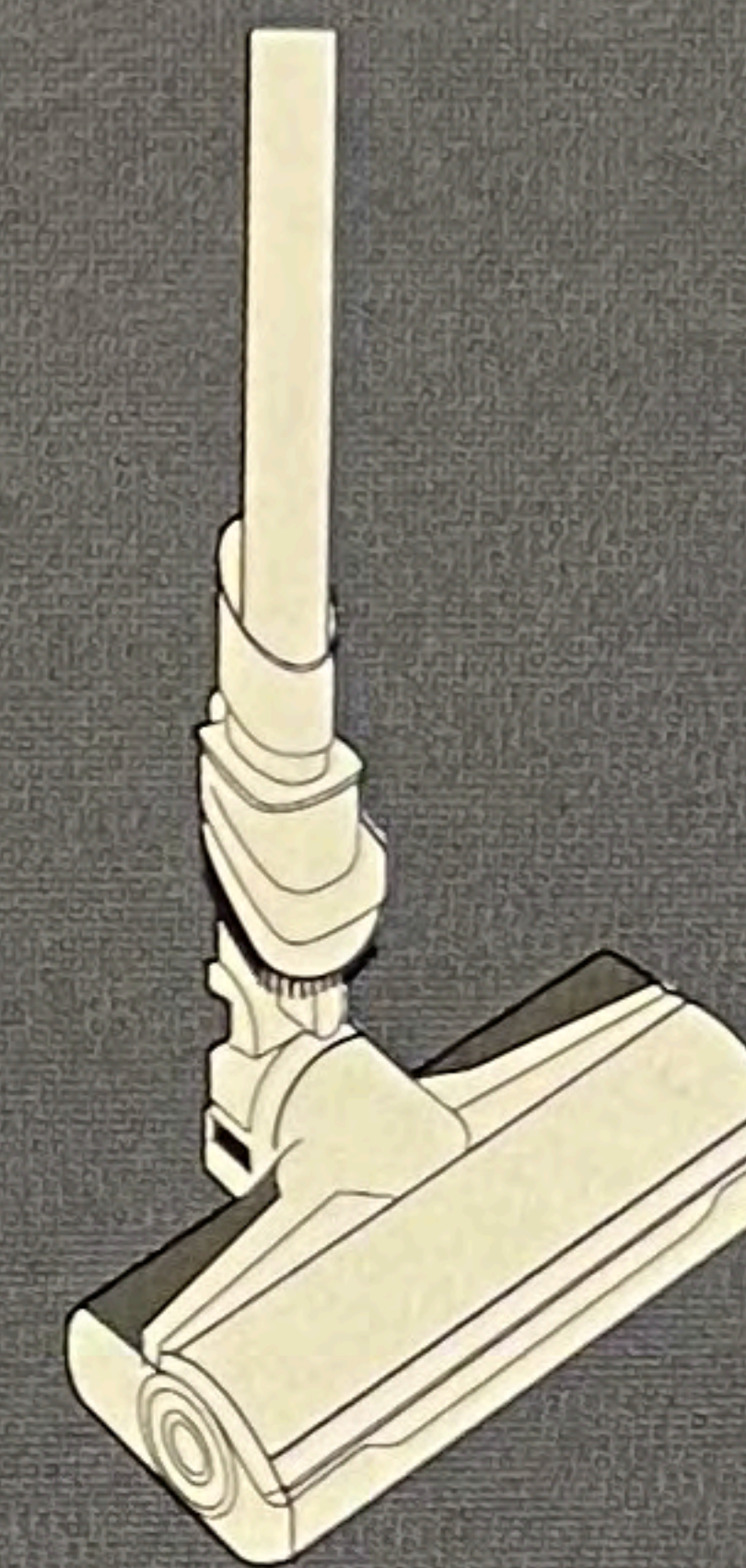
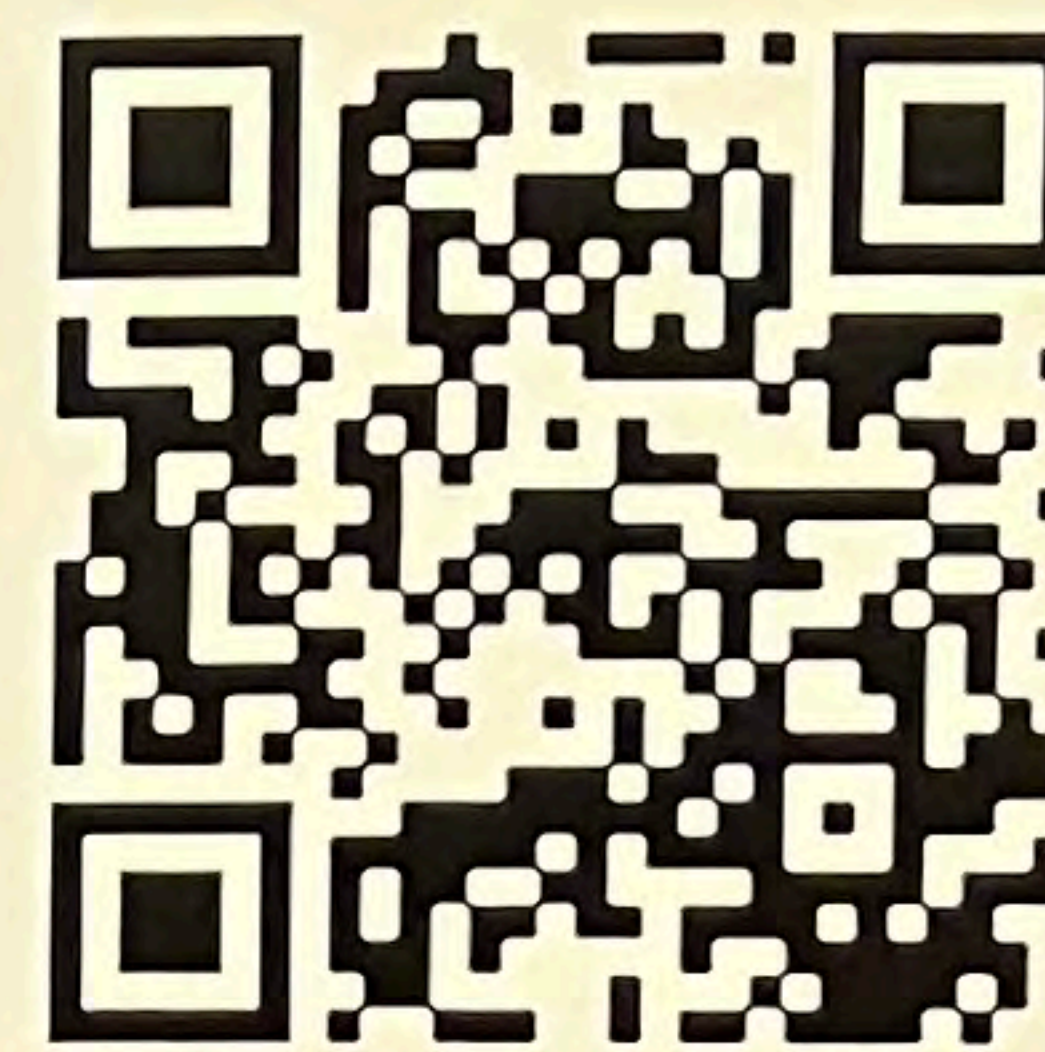

CLICK

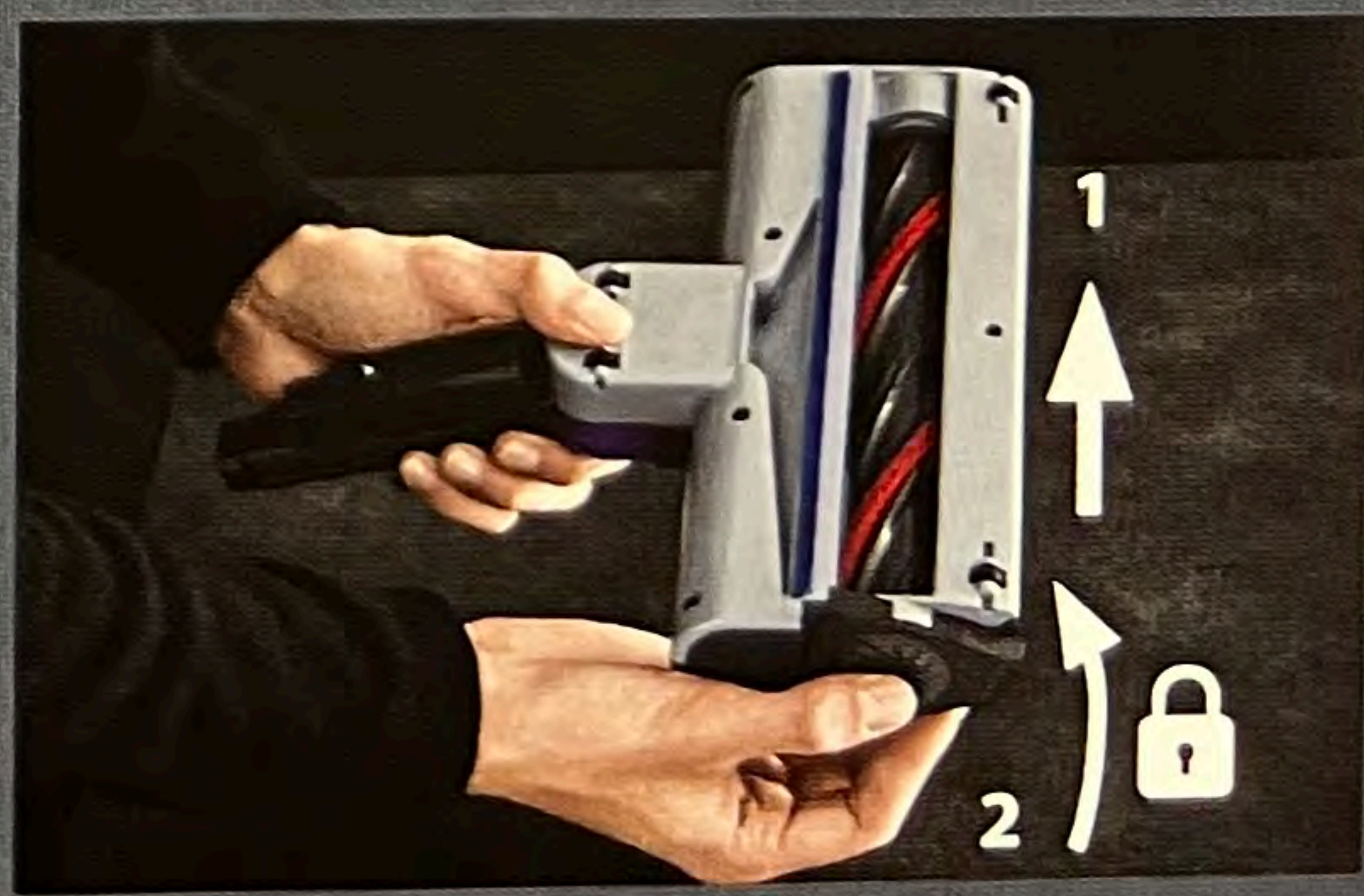
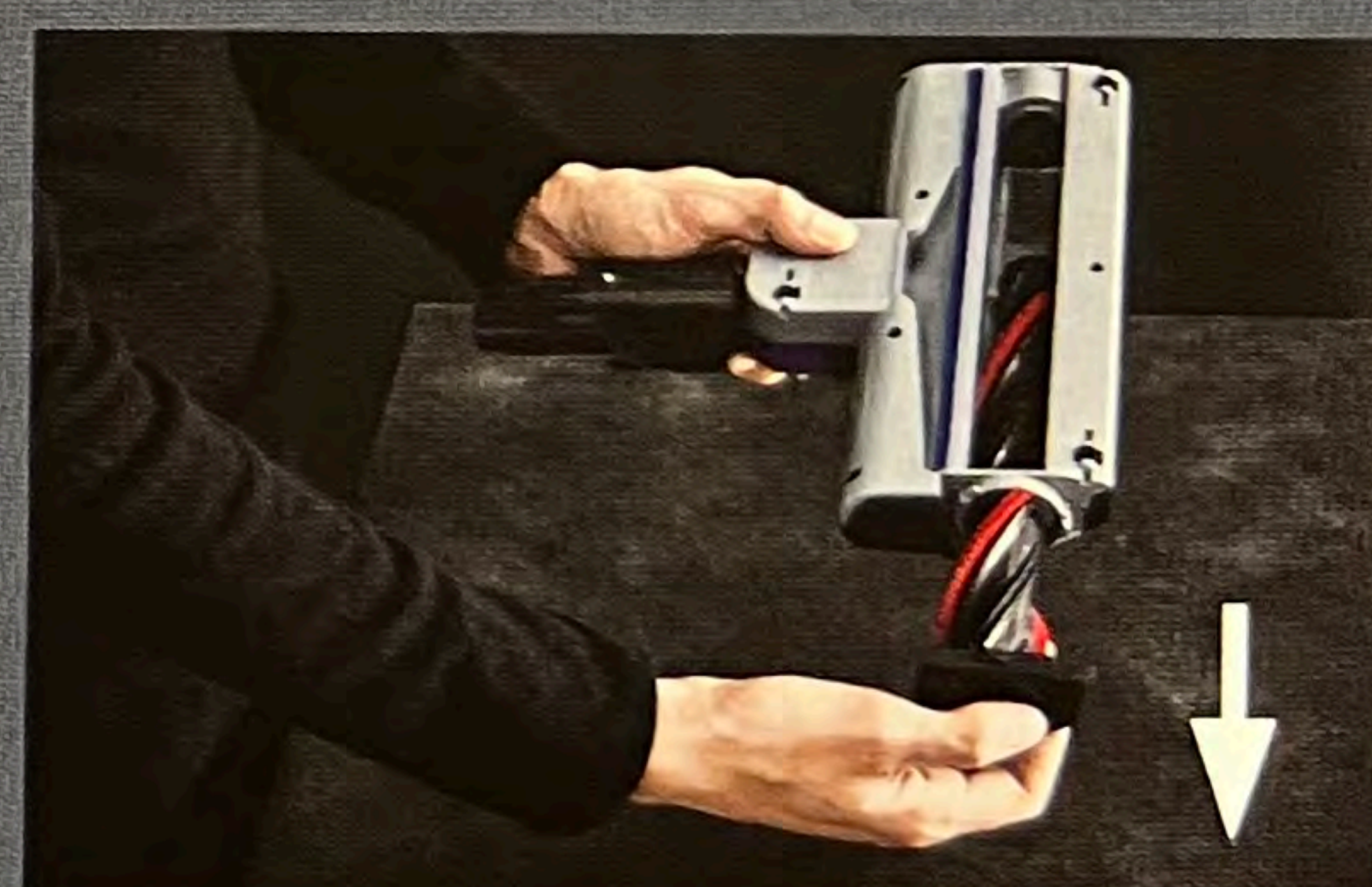
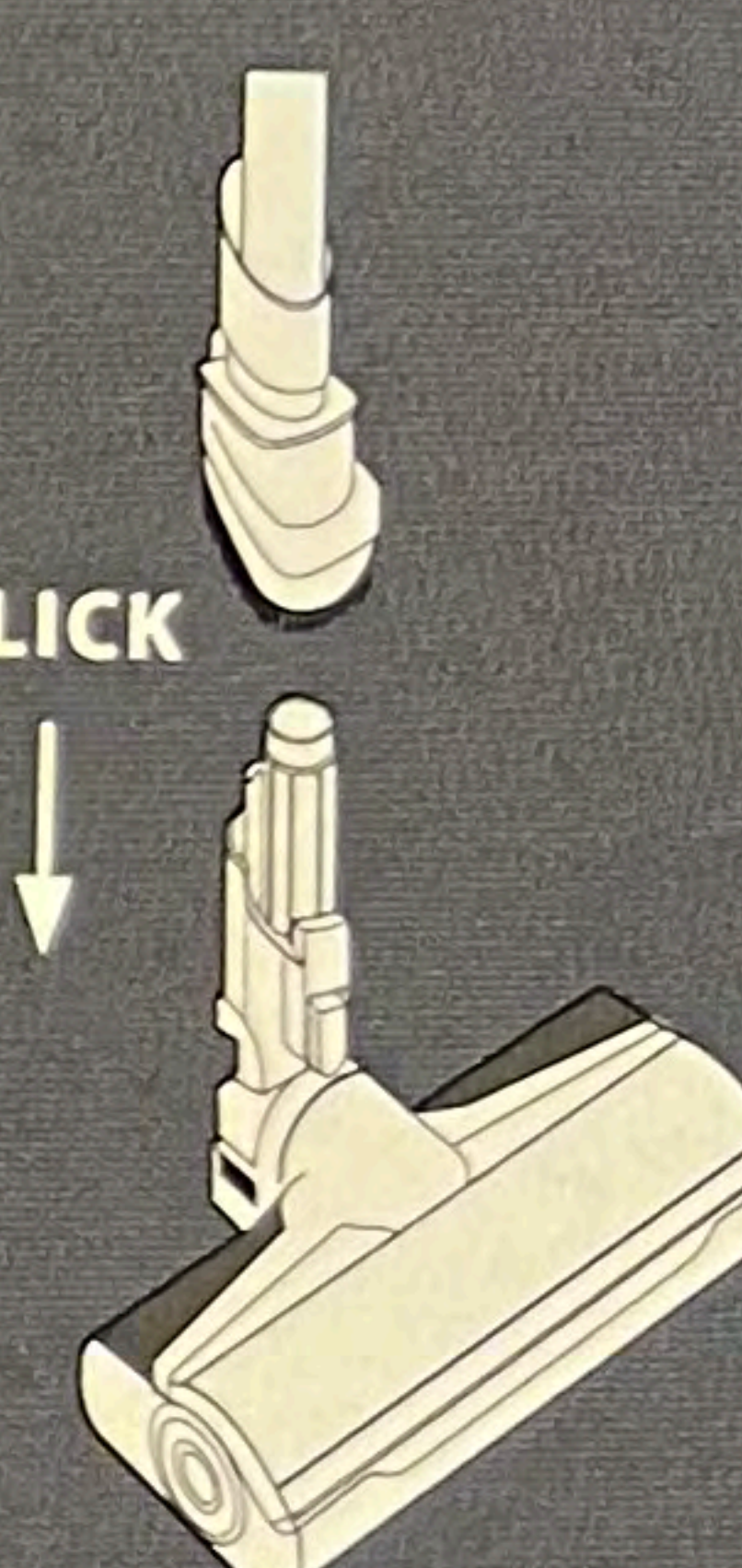

* EN Not included / FR Non inclus / DE Nicht im Lieferumfang enthalten / NL Niet inbegrepen / ES No incluidos / PT Nao incluidos / IT Non incluso / TR Dahil değil / CS Není součástí balení / SK Nezahrnuté / HU Nem tartozék / PL Nie zawiera / ET Valja arvatud / LT Nėra įtraukta / LV Nav ietverts / BG Не са включени / RO Neinclus / SL Ni vključeno / HR Nisu uključeni / BS Nije uključeno / SR Nije uključeno / RU Не включено / EL Δεν περιλαμβάνονται / UK Не включено / CN 不包括 / HK 不包括 / KO 포함되지않음 / AR غير مُرفقة / FA شامل نمی شود / FI Ei sisally / NO ikke inkludert / DA ikke inkluderet / SU ingar ej - MY Tidak termasuk



NO



NO



YES

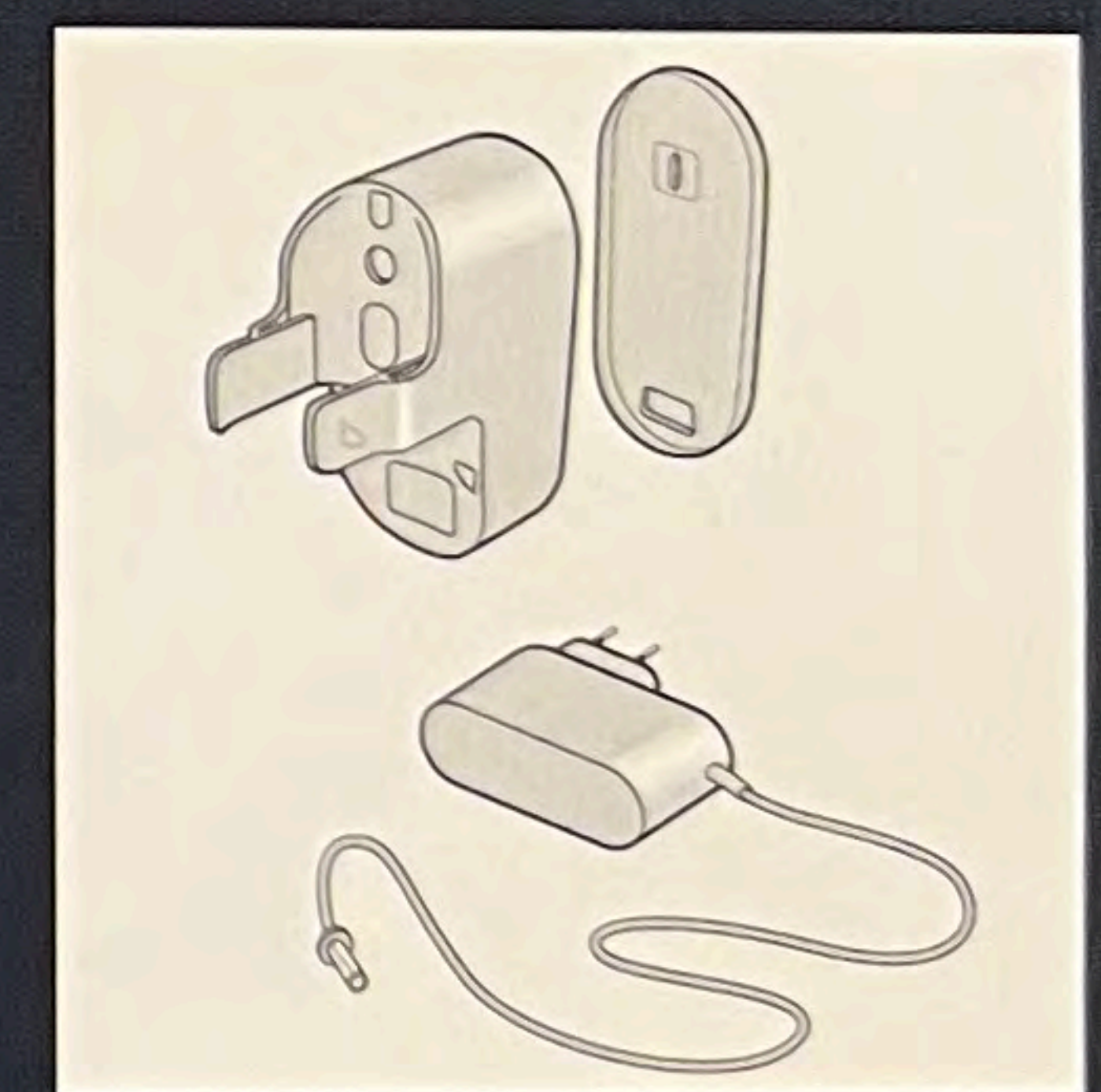
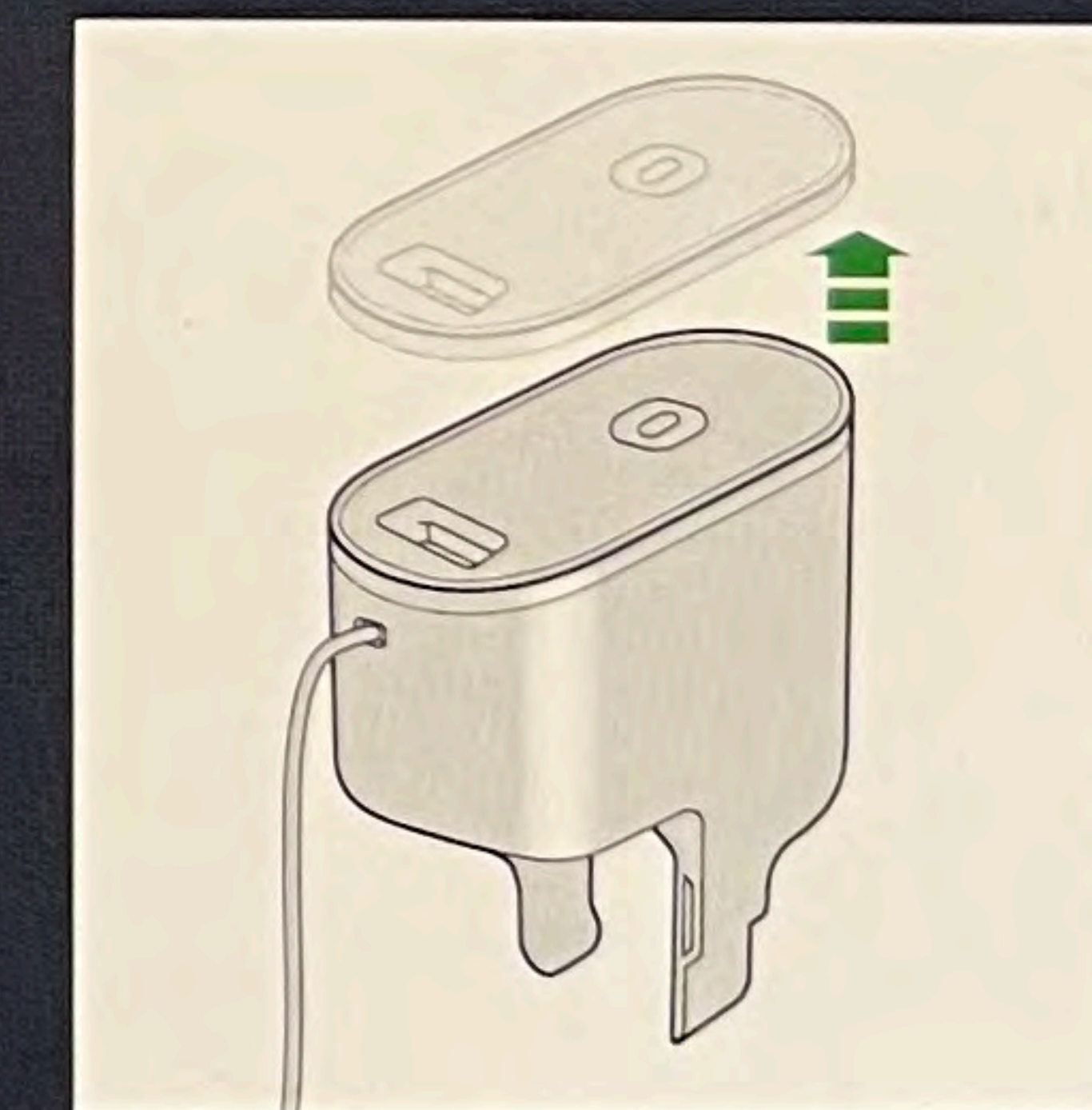
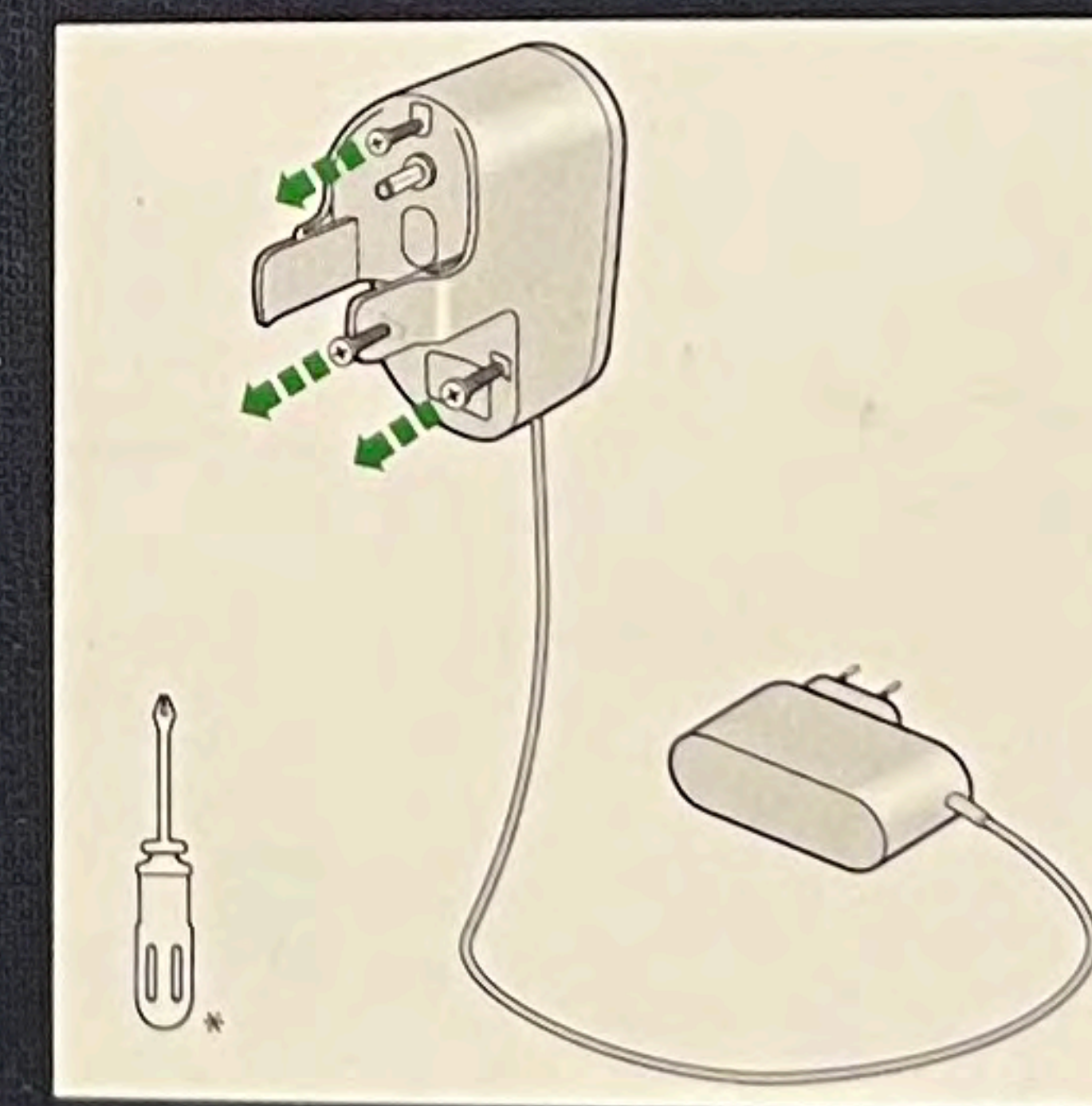
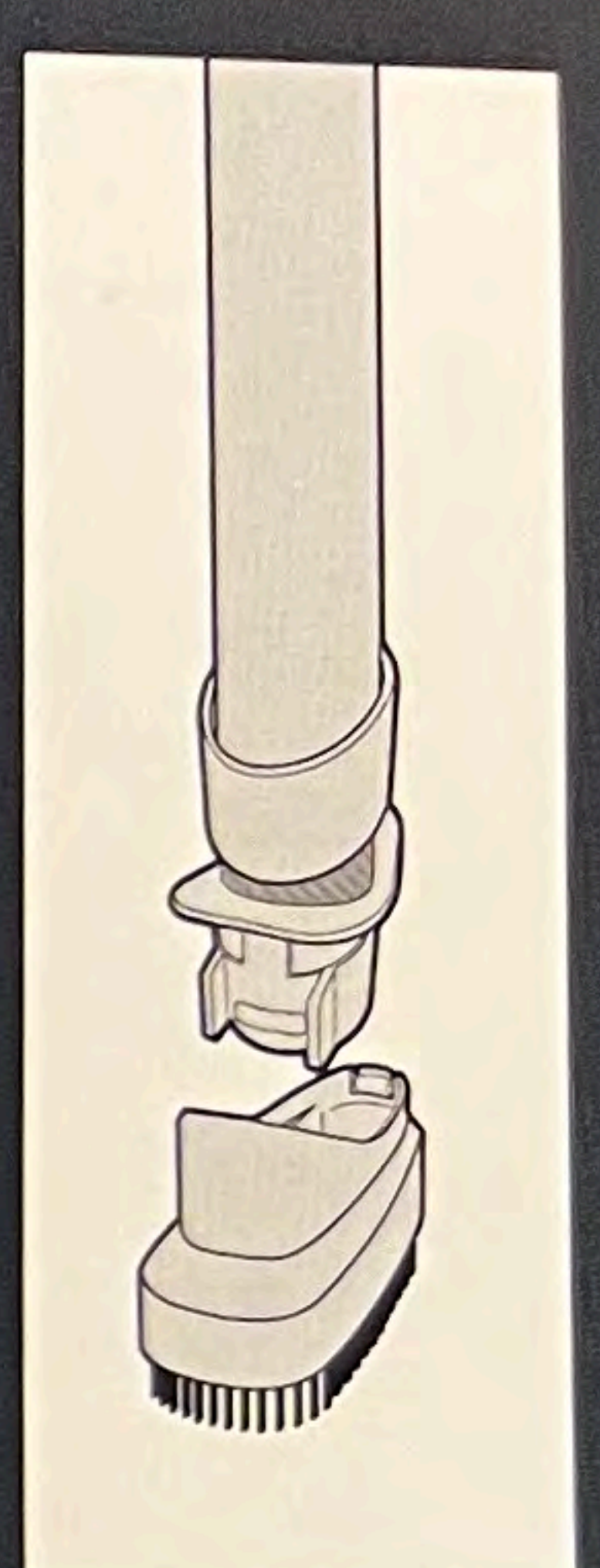
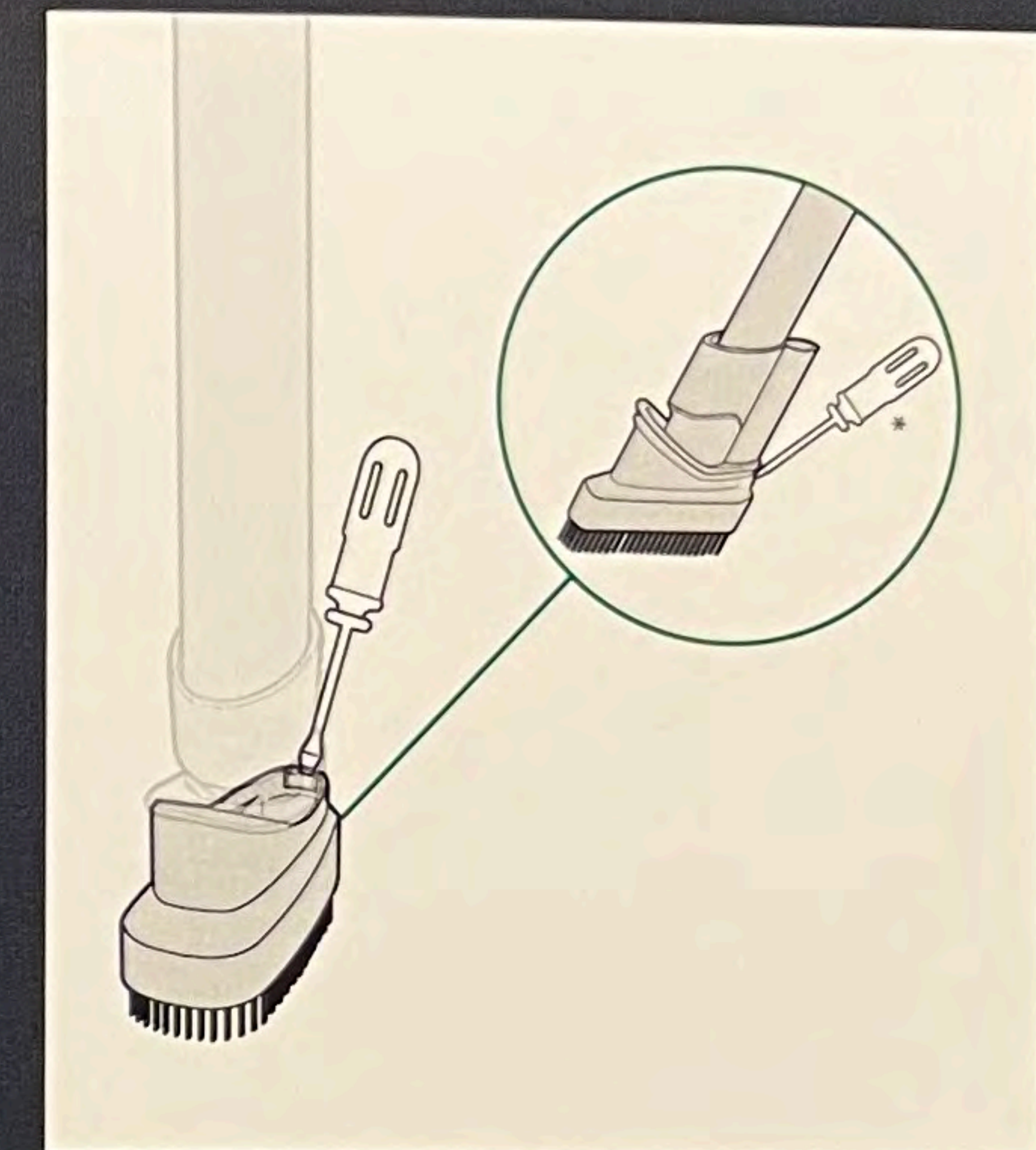
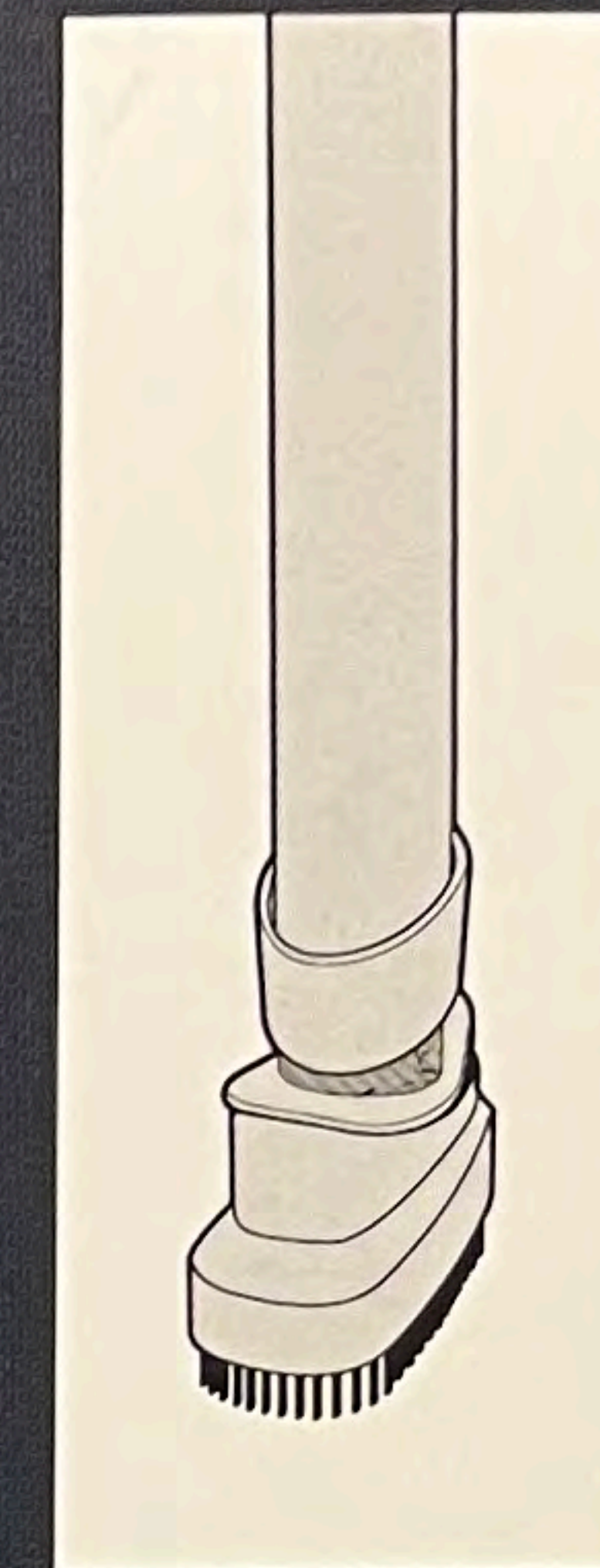
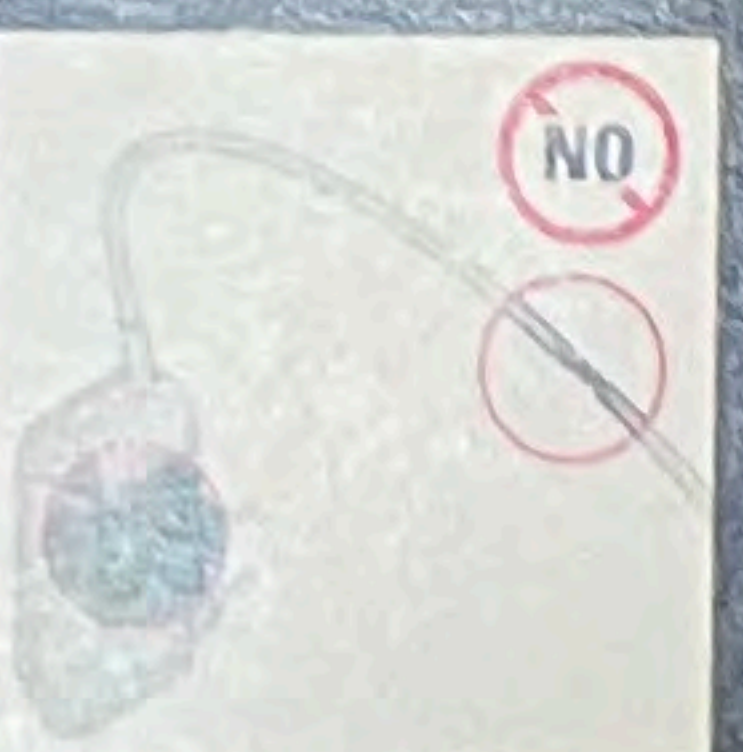
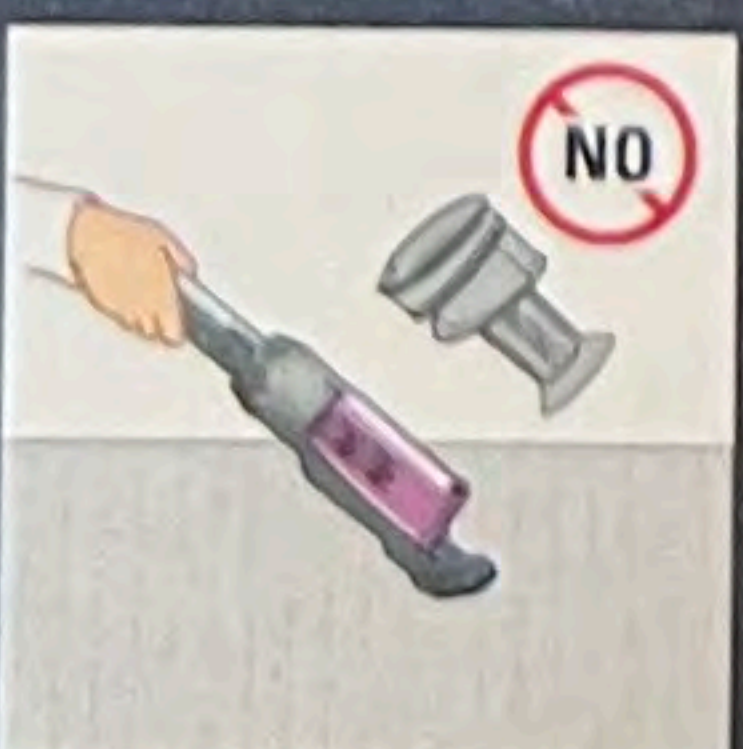
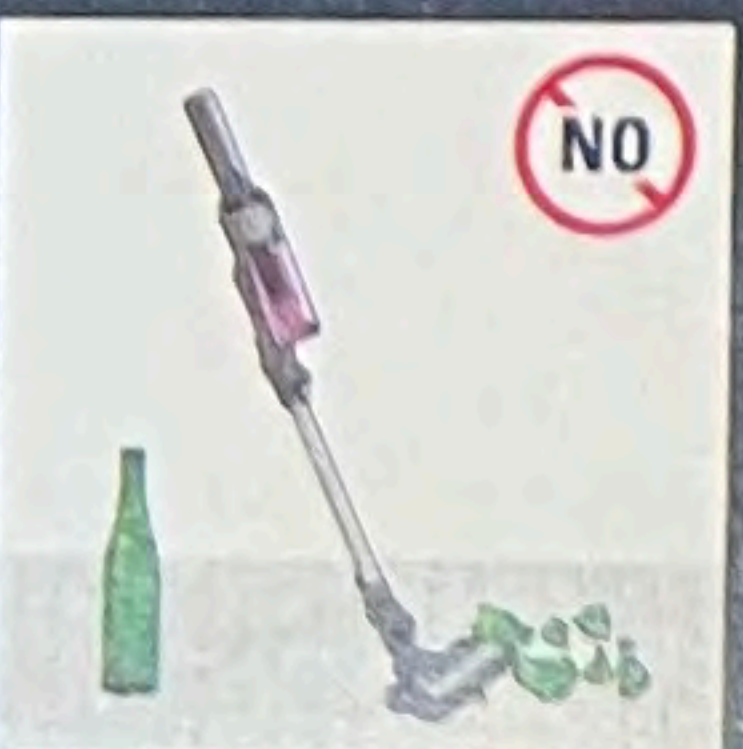
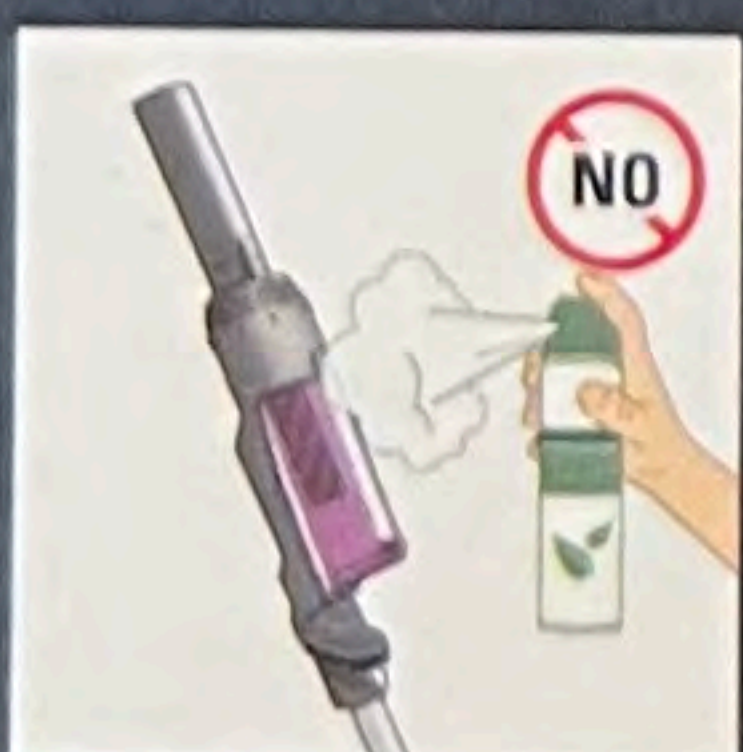
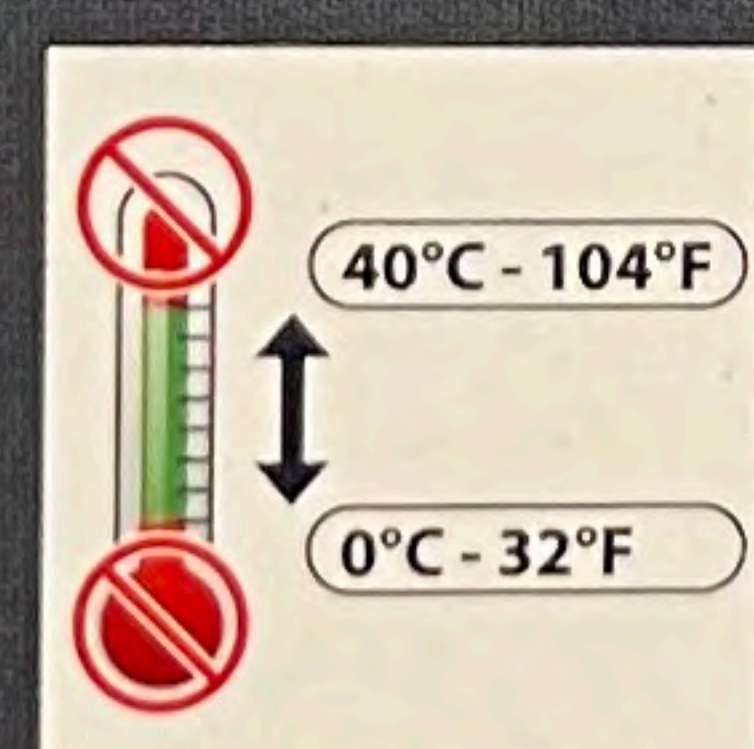
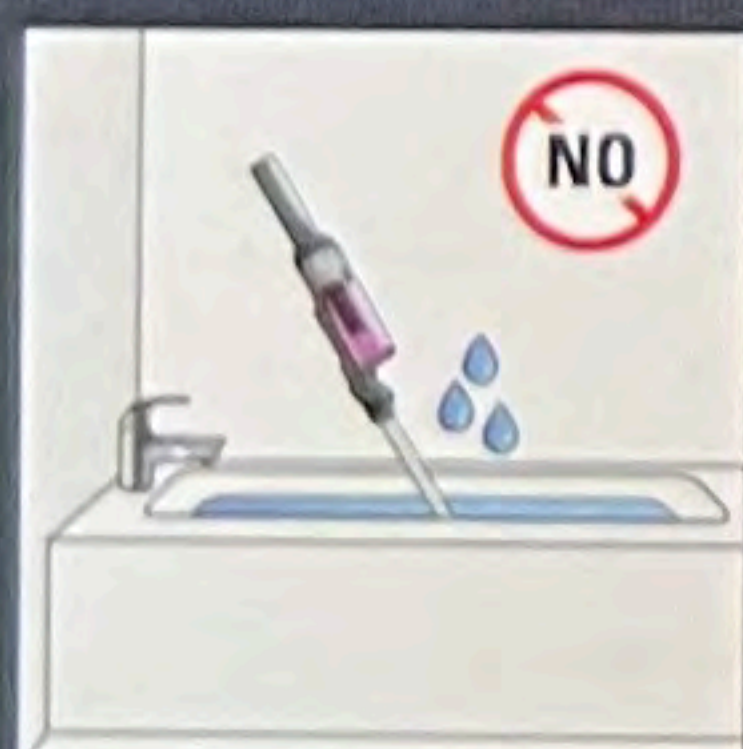
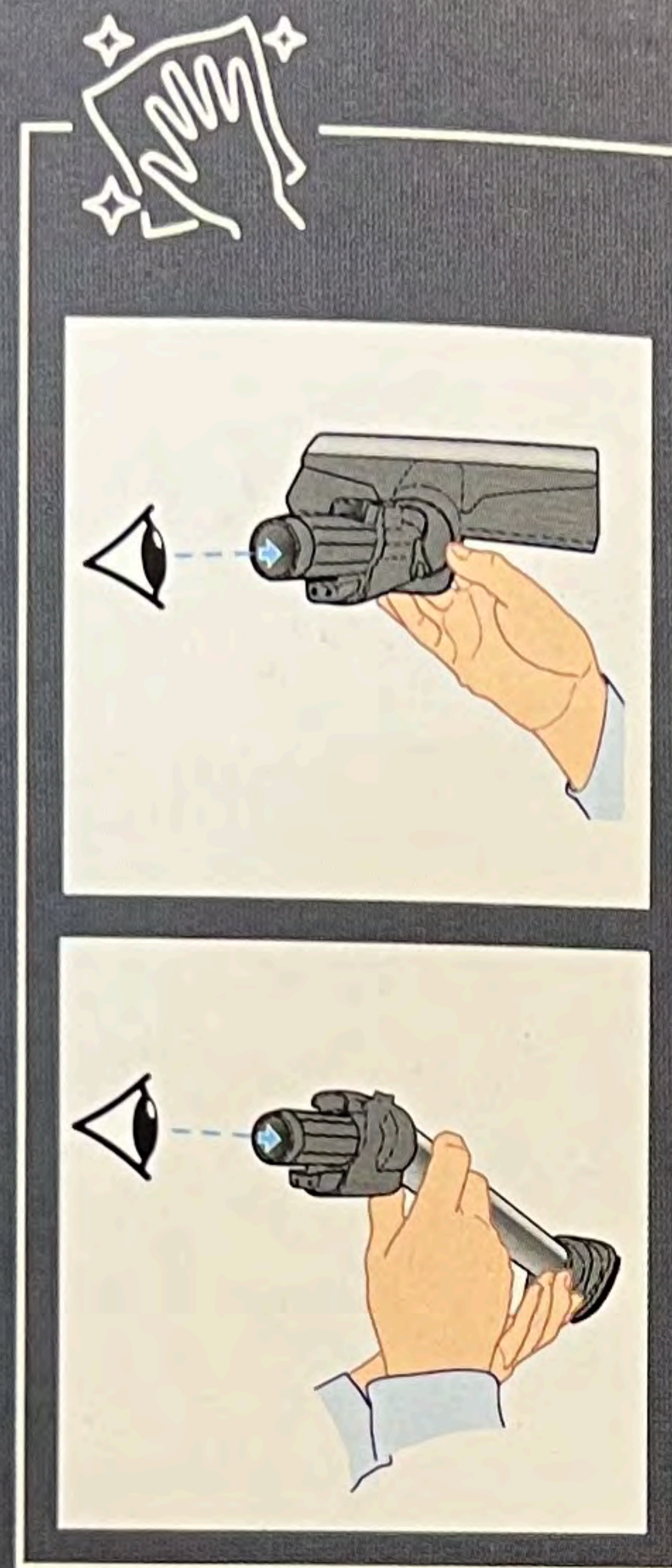

* EN Not included / FR Non inclus / DE Nicht im Lieferumfang enthalten / NL Niet inbegrepen / ES No incluidos / PT Nao incluidos / IT Non incluso / TR Dahil değil / CS Není součástí balení / SK Nezahrnuté / HU Nem tartozék / PL Nie zawiera / ET Valja arvatud / LT Nėra įtraukta / LV Nav ietverts / BG Не са включени / RO Neinclus / SL Ni vključeno / HR Nisu uključeni / BS Nije uključeno / SR Nije uključeno / RU Не включено / EL Δεν περιλαμβάνονται / UK Не включено / CN 不包括 / HK 不包辦 / KO 포함되지않음 / AR غير مرفقة / FA شامل نمی شود / FI Ei sisally / NO ikke inkludert / DA ikke inkluderet / SU ingar ej - MY Tidak termasuk

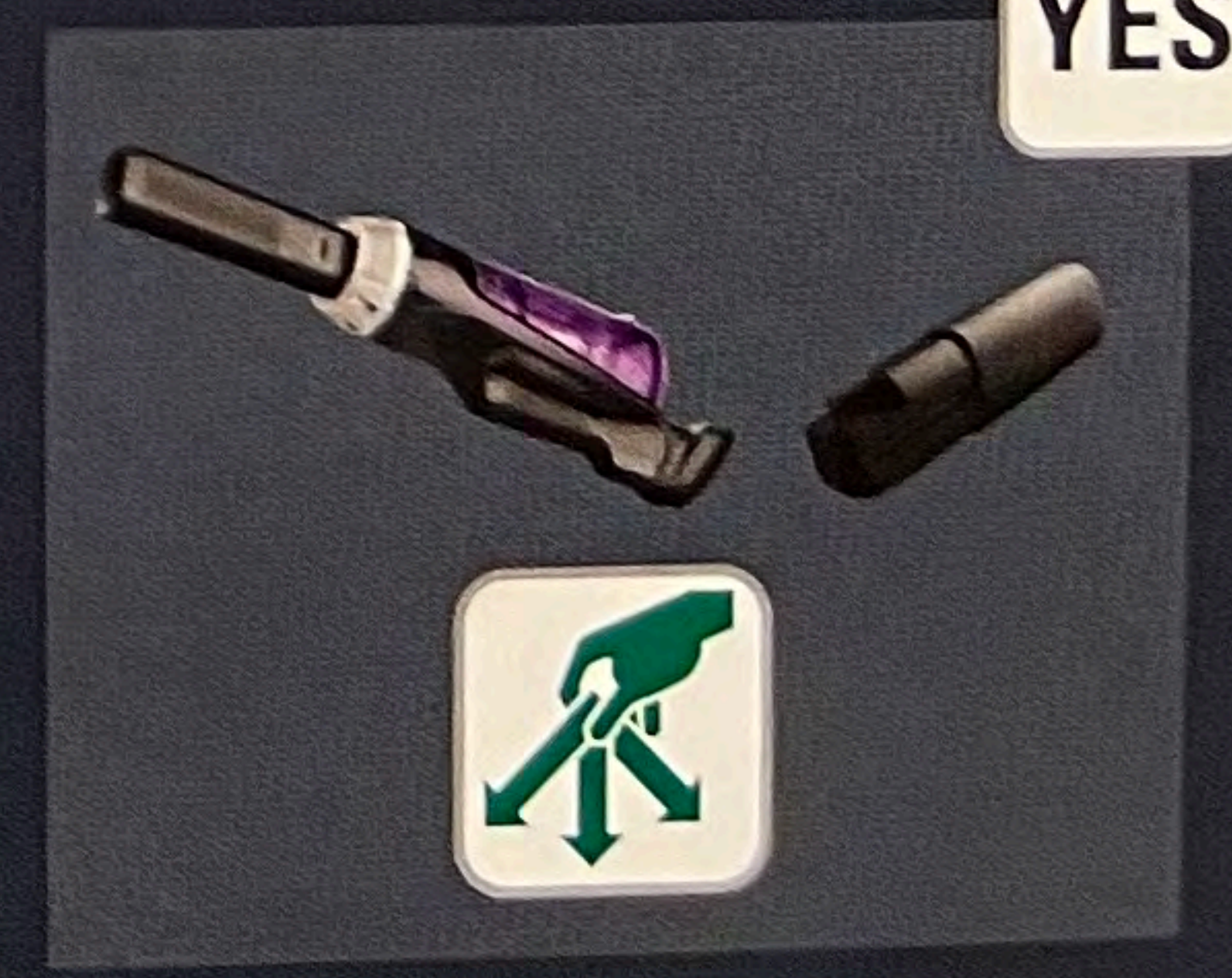
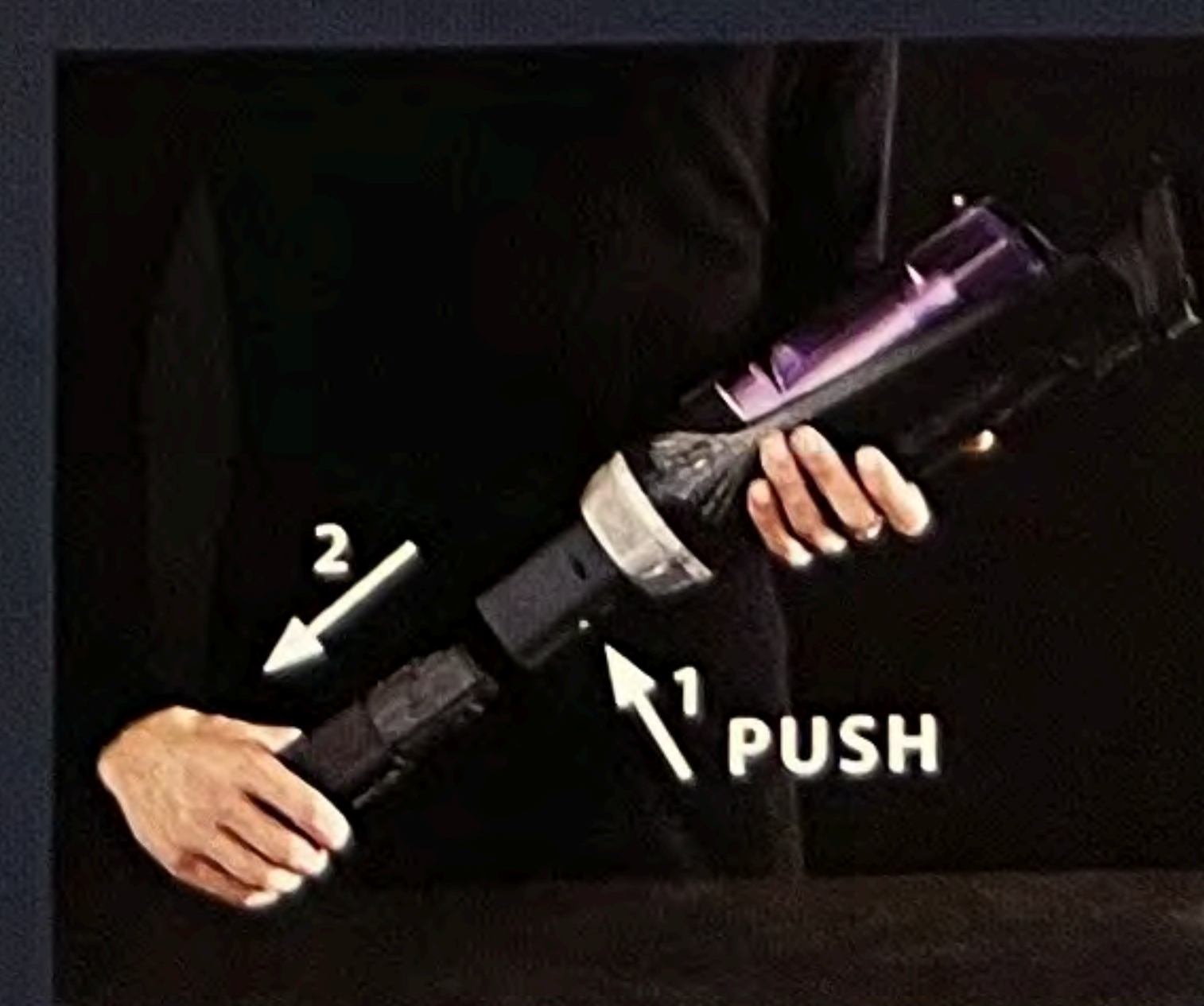



15 YEARS REPARABILITY



FR Réparable au juste prix 15 ans
 DE Reparierbarkeit zum fairen Preis
 15 Jahre
 IT Riparabile al giusto prezzo 15 anni
 ES Reparable a un precio justo 15 años
 RU Возможность ремонта по честной
 цене 15 лет
 PL Naprawialny za rozsądną cenę 15 lat
 NL Reparatie voor een redelijke prijs
 15 jaar
 PT Reparável a um preço justo 15 anos
 FI Korjattavissa kohtuulliseen hintaan
 15 vuotta
 NO Kan repareres til rimelig pris 15 år
 DA Kan repareres til rimelige priser 15 års

SU Reparationsbar till rimligt pris 15 år
 MY R boleh dipasang pada harga wajar
 15 tahun
 TR Uygun fiyata tamir edilebilir 15 yıl
 CS Opravitelné za přijatelnou cenu 15 let
 SK Opravitelné za prijateľnú cenu 15
 rokov
 HU Gazdaságosan javítható 15 év
 ET Õiglase hinnaga parandata 15 aastat
 LV Galima taisyti už sąžiningą kainą
 15 metų
 LT Remontėjams par godigū cenu 15 gadi
 BG Сервизна поддръжка на разумна
 цена 15 години
 RO Reparabil la un preț accesibil 15 ani

SL Popravljivo za sprejemljivo ceno
 15 LET
 HR Pristupačna cijena popravka
 15 godina
 BS Popravljiv po poštenoj cijeni
 15 godina
 SR Popravka po pristupačnoj ceni
 15 godina
 UK Можливість ремонту за
 справедливою ціною 15 років
 HK 合理的維修價格 15年
 KR 합리적인 수리비용 15년
 AR قابل للإصلاح بسعر عادل 15 سنة

FOR MORE INFORMATION

FR Pour plus d'informations / DE Weitere Informationen / NL Voor meer informatie / ES Para más información / PT Para mais informações / IT Per ulteriori informazioni / EL Για περισσότερες πληροφορίες / TR Daha fazla bilgi için / CS Více informací naleznete zde / SK Pre viac informácií / HU További információk / PL Więcej informacji można znaleźć / ET Lisateave / LT Norėdami daugiau informacijos / LV Vairāk informācijas / BG За повече информация / RO Pentru informații suplimentare / SL Več informacij / HR Za više informacija / BS Za više informacija / SR Za više informacija / RU Для получения дополнительной информации / UK Для отримання докладніших відомостей / CN 获取更多信息 / HK 更多信息 / KO 더 자세한 정보는 아래 웹사이트에서 확인하실 수 있습니다 / AR للمزيد من المعلومات / FA برای کسب اطلاعات بیشتر / FI Lisätietoja / NO For mer informasjon / DA For mere information / SU För mer information / MY Untuk maklumat selanjutnya

www.rowenta.com

www.tefal.com

www.obhnordica.se

2220005127-01 - 45/2021